

# KWC

## KWC IQUA style / design

802649

Installation and Service Manual

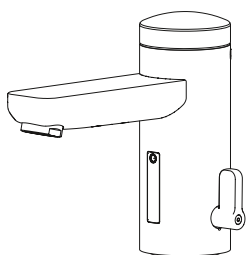

**12.696.061.000**  
**12.696.071.000**

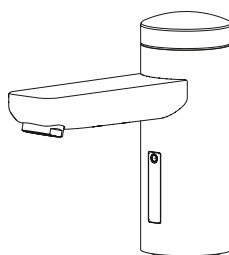

**12.696.151.000**  
**12.696.161.000**

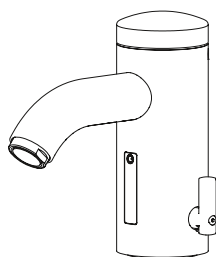

**12.696.081.000**  
**12.696.091.000**

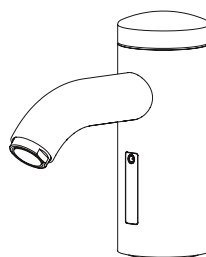

**12.696.171.000**  
**12.696.181.000**

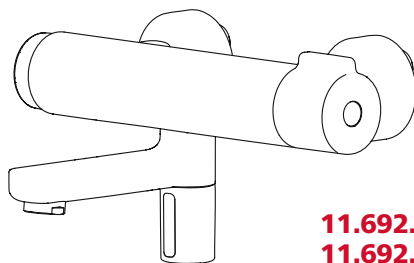

**11.692.083.000**  
**11.692.093.000 INT**



**EN** Installation and service manual  
**DE** Installations- und Serviceanleitung  
**FR** Manuel d'installation et d'entretien  
**IT** Manuale per l'installazione e il servizio di assistenza

Bathroom Faucet  
Badarmatur  
Robinet de salle de bain  
Rubinetto del bagno



Information, Information, Information, Informazioni



Installation, Installation, Installation, Installazione



Cleaning, Reinigung, Nettoyage, Pulizia



Periodic checks, Regelmässige Kontrolle, Contrôles périodiques, Controlli periodici



Appropriate tools, Geeignete Werkzeuge, Outils appropriés, Strumenti appropriati



12.696.061.000  
12.696.071.000  
12.696.151.000

12.696.161.000  
12.696.081.000  
12.696.091.000

12.696.171.000  
12.696.181.000

## Richtlinien zur Installation

- Wasserleitungsdrücke von Warmwasser und Kaltwasser müssen gleich sein.
- Installation und Lagerung nur in frostsicheren Räumen.
- Ab Datum des Erwerbes (Kaufbeleg) gewähren wir eine Garantie von 2 Jahren.

## Installation guidelines

- The water pressure for both the hot and cold water pipes should be equal.
- Install and store in frost-proof rooms only.
- We will guarantee the products for 2 years from the date of acquisition.

## Direttiva per l'Installazione

- Si prega di osservare le norme esistenti per l'installazione e l'allacciamento all'impianto idrico.
- Si consiglia l'installazione con pressioni dell'acqua calde e fredde equilibrate.
- Garantiamo il prodotto per 2 anni dalla data di acquisto.

## Directives d'installation

- Respecter les normes en vigueur et les conditions de raccordement au réseau d'eau local.
- L'eau chaude et l'eau froide doivent avoir la même pression.
- Nous accordons une garantie de 2 ans sur les produits à partir de la date d'achat (ticket de caisse).

## Installation

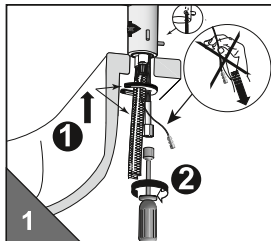

## Installation

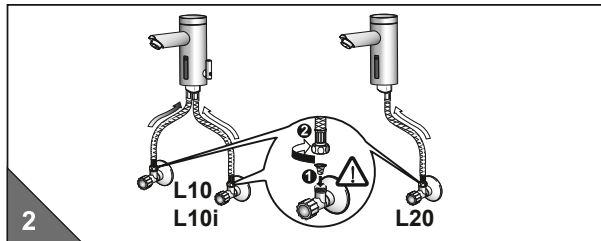

## Installazione

## Installation

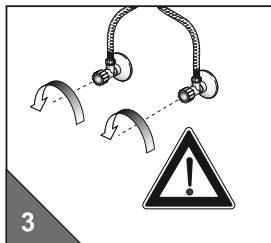

- Wassermenge einstellen!
- Adjust water quantity!
- Regolazione acqua!
- Régler la quantité d'eau!

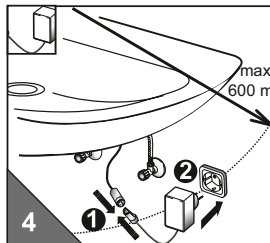

- Spannungsversorgung herstellen
- Connect to the power supply
- Stabilire l'alimentazione di tensione
- Etablir l'alimentation électrique



## Inbetriebnahme

## Preparing for operation

## Messa in funzione

## Mise en service

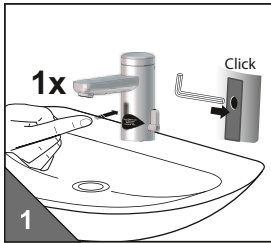

1x Taste drücken...  
Aufkleber entfernen...  
Press the key once...  
remove sticker...  
Premere il tasto 1x...  
Rimuovere adesivo...  
Appuyez 1x sur la touche...  
Retirez l'autocollant...

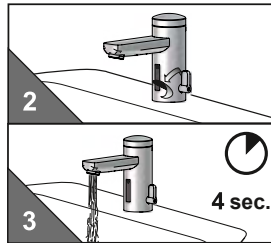

... Wasser fließt ca. 4 sec....  
... water flows for approx. 4 sec....  
... l'acqua scorre per ca. 4 sec...  
... l'eau coule env. 4 sec....

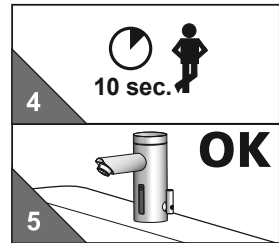

... 10 sec. warten – betriebsbereit  
... wait 10 sec. – ready for use  
... attendre 10 sec. –  
pronto per il servizio  
... attendez 10 sec. – opérationnel

## Funktionen

## Functions

## Funzioni

## Fonctions

- Wasser "Ein"
- Water flow "On"
- Flusso aperto
- Ecoulement ouvert

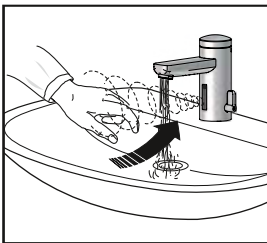

- Wasser "Aus"
- Water flow "Off"
- Flusso chiuso
- Ecoulement fermé

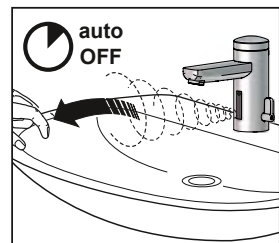

## Temperatur- einstellung

## Adjusting the temperature

## Impostazione della temperatura

## Réglage de la température

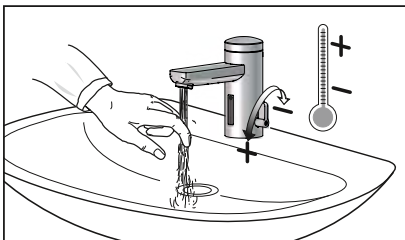



12.696.061.000  
12.696.071.000  
12.696.151.000

12.696.161.000  
12.696.081.000  
12.696.091.000

12.696.171.000  
12.696.181.000

### iqua-Klick (Komfort-Taste)

- Dauer Ein
- Continuous On
- Continou On
- Ecoulement continu

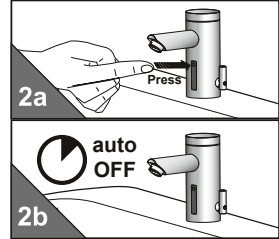
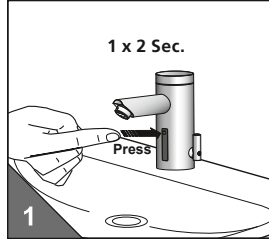

- „Kurz Aus“
- „Intermittent Off“
- Possibilità di interruzione del funzionamento
- Interruption brève

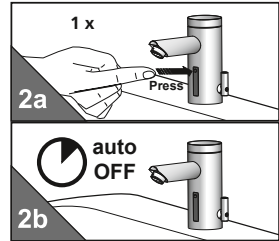
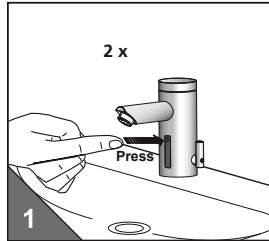

### Wassernachlaufzeit einstellen

### Changing Time of water flow

### Impostare il tempo di coda dell'acqua

### Réglage du post- écoulement de l'eau

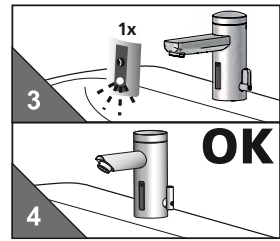
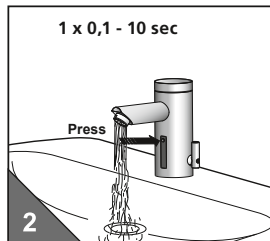
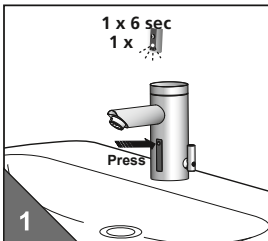

- Taste 5 sec. drücken, loslassen...
- Press the key for approx. 5 sec. Release...
- Premere il tasto per ca. 5 sec., poi rilasciarlo...
- Appuyez pendant env. 5 sec. sur la touche, relâchez...

- ... erneut drücken, Wasser „EIN“, 1 sec. – 10 sec. gedrückt halten, loslassen
- ...press again. Hold down water „ON“ for 1 sec. – 10 sec. release.
- ...premere nuovamente, tenere premuto acqua „ON“ per 1 sec. – 10 sec., poi rilasciarlo
- ...appuyez à nouveau, „Ecoulement ouvert“, tenez la touche enfoncée 1 sec. - 10 sec., relâchez



**Wasserlaufzeit:  
„Dauer-Ein“ und  
„12/24/48 Stunden  
Hygienespülung“**

- Wasserlaufzeit:  
„12/24/48 Stunden  
Hygienespülung“  
entspricht „Dauer-Ein“

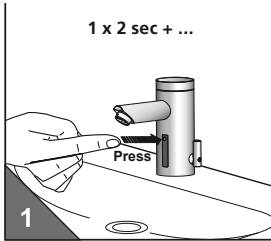

- Taste 2 sec. drücken, loslassen...
- Press the key for 2 sec. Release...
- Premere il tasto per 2 sec., poi rilasciarlo...
- Appuyez pendant 2 sec. sur la touche, relâchez...

**Water flow duration: Durata acqua:  
„Continuous On“ and  
„12/24/48 hours  
automatic flush“**

- Water flow duration:  
„12/24/48 hours  
automatic flush“ equates  
to „Continuous On“
- Durata acqua:  
„Scarico forzato ogni  
12/24/48 ore“ equivale a  
„Continuo On“

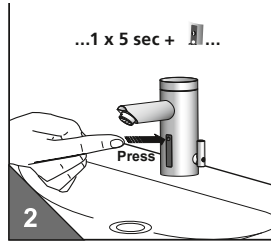

- ...erneut drücken und gedrückt halten ...
- ...press again and hold down...
- ...premere nuovamente e tenere premuto...
- ...appuyez à nouveau et tenez la touche enfoncée ...

**Période de l'eau:  
„Ecoulement Continu“  
e „Rinçage forcé  
12/24/48 heures“**

- Période de l'eau:  
„Rinçage forcé 12/24/48  
heures“ équivaut à  
„Ecoulement Continu“

...1 x  = 0,5 min
...2 x  = 1,0 min
...3 x  = 1,5 min
... .. ..
...38 x  = 19,0 min
...39 x  = 19,5 min
...40 x  = 20,0 min

- ...nach gewünschter Laufzeit loslassen.
- ...release after the required flow duration.
- ...rilasciare dopo il tempo di scorrimento desiderato.
- ...relâchez après la durée souhaitée.

**12/24/48 Stunden  
Hygienespülung**

- Wasserlaufzeit:  
„12/24/48 Stunden  
Hygienespülung“  
entspricht „Dauer-Ein“

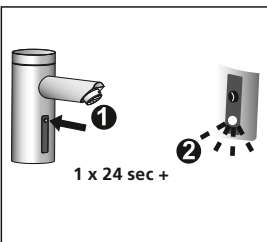

- 1x 24 sec. Taste drücken bis...
- Press key 1x 24 sec. until...
- Premere il tasto brevemente 1x24 sec. finché...
- Appuyez pendant env. 1x 24 sec. sur la touche jusqu'à ce que...

**12/24/48 hours  
automatic flush**

- Water flow duration:  
„12/24/48 hours  
automatic flush“ equates  
to „Continuous On“

**Scarico forzato  
ogni 12/24/48 ore**

- Durata acqua: „Scarico  
forzato ogni 12/24/48  
ore“ equivale a  
„Continuo On“

**Rinçage forcé  
12/24/48 heures**

- Période de l'eau:  
„Rinçage forcé 12/24/48  
heures“ équivaut à  
„Ecoulement Continu“

		<b>h</b>
- deaktivieren - disattivare	- deactivate - désactiver	1x -----
- aktivieren - attivare	- activate - activer	2x 12 h
		3x 24 h
		4x 48 h

- ...LED 1 – 4x blinkt – Taste loslassen...
- ...LED flashes 1 – 4x – Release...
- ...il LED non lampeggia 1 – 4x – rilasciare...
- ...la LED clignote 1 - 4x – relâchez...

- ...betriebsbereit
- ...ready for use
- ...pronto per il servizio
- ...opérationnel



12.696.061.000  
12.696.071.000  
12.696.151.000

12.696.161.000  
12.696.081.000  
12.696.091.000

12.696.171.000  
12.696.181.000

### Automatische Sensoreinmessung

### Automatic sensor adjustment

### Misurazione automatic

### Réglage automatique de la cellule

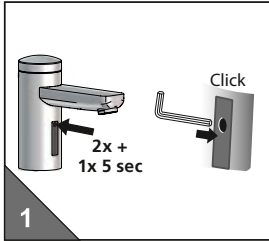

- 2x kurz und 1x 5 sec. Taste drücken bis...
- Press key twice, press again and hold down for app. 5 sec. until...
- Premere il tasto brevemente 2x e 1x per 5 sec. finché...
- Appuyez 2x brièvement et 1x pendant 5 sec. sur la touche jusqu'à ce que...

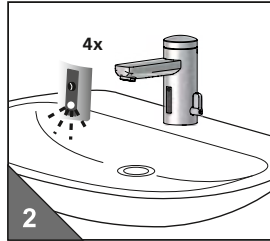

- ...LED 4x blinkt - Taste loslassen...
- ...LED flashes 4 times. Release...
- ...il LED lampeggia 4x - rilasciare...
- ...la LED clignote 4x - relâchez...



- ...15 sec. warten...
- ...wait 15 sec.
- ...attendre 15 sec.

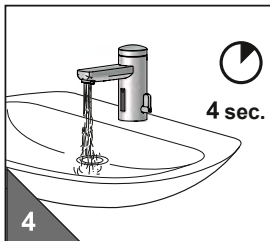

- ...Wasser fließt ca. 4 sec....
- ...Water flows for approx. 4 sec....
- ...L'acqua scorre per ca. 4 sec....
- ...L'eau coule env. 4 sec....

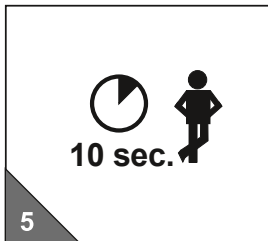

- ...10 sec. warten...
- ...wait 10 sec....
- ...attendere 10 sec....
- ...attendez 10 sec....



- ...betriebsbereit
- ...ready for use
- ...pronto per il servizio
- ...opérationnel





## Einstellung der Sensorreichweite

## Setting the sensor range

## Impostazione della portata del sensore

## Réglage de la portée du détecteur

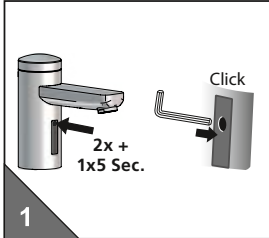

- 2x kurz und 1x 5 sec. Taste drücken bis...
- Press key twice, press again and hold down for app. 5 sec. until...
- Premere il tasto brevemente 2x e 1x per 5 sec. finché...
- Appuyez 2x brièvement et 1x pendant 5 sec. sur la touche jusqu'à ce que...

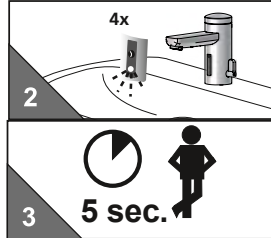

- ...LED 4x blinkt - Taste gedrückt halten...
- ...LED flashes 4 times - hold pressed...
- ...il LED lampeggia 4x - e tenere premuto...
- ...la LED clignote 4x - et tenez la touche enfoncée...

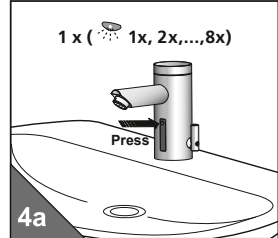

- ...Taste drücken bis LED blinkt...
- ...hold down the key until the LED flashes...
- ...premere il tasto finché il LED lampeggia...
- ...appuyez sur la touche jusqu'à ce que la DEL clignote...

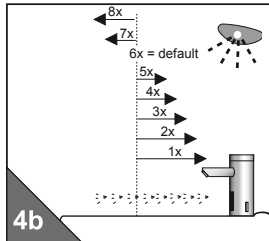

- LED blinkt: 1x = min... 8x = max., loslassen
- LED flashes: 1x = min... 8x = max., release
- LED lampeggia: 1x = min... 8x = max., rilasciare
- LED clignote: 1x = min... 8x = max. relâchez

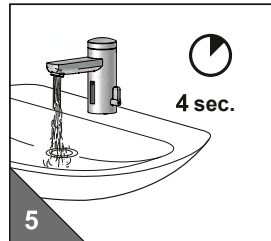

- ... Wasser fließt ca. 4 sec...
- ...water flows for approx. 4 sec...
- ...l'acqua scorre per ca. 4 sec...
- ...l'eau coule env. 4 sec....

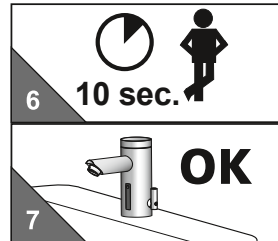

- ... 10 sec. warten - betriebsbereit
- ...wait 10 sec.; ready for use
- ...attendere 10 sec. - pronto per il servizio
- ...attendez 10 sec. - opérationnel



12.696.061.000  
12.696.071.000  
12.696.151.000

12.696.161.000  
12.696.081.000  
12.696.091.000

12.696.171.000  
12.696.181.000

**Heisswassersperre  
einstellen**

**Adjusting the hot  
water limitation**

**Impostare il blocco  
dell'acqua calda**

**Réglage du robinet  
d'eau chaude**

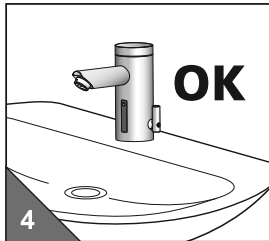
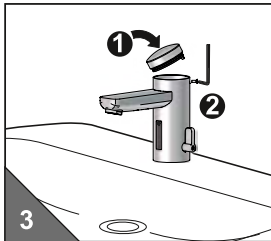
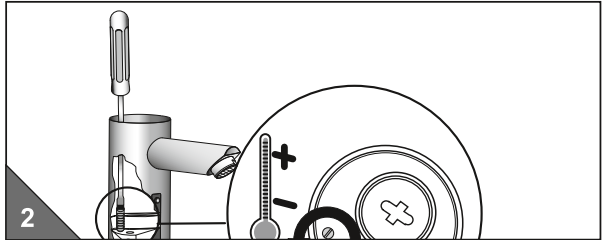
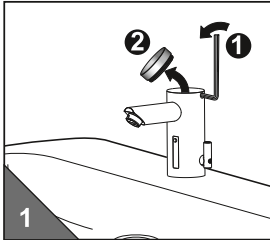

**Schmutz-  
sieb-  
Reinigung**

**Cleaning  
the filters**

**Pulire  
il filtro**

**Nettoyage  
du tamis**

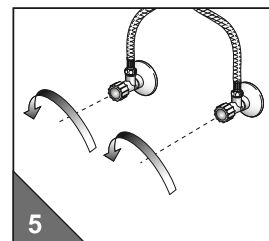
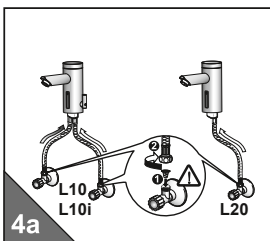
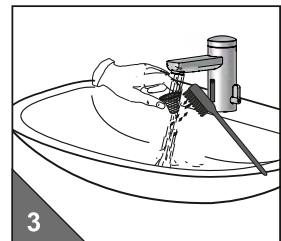
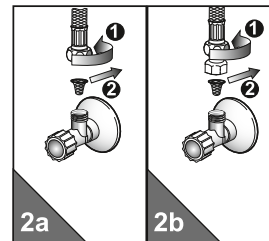
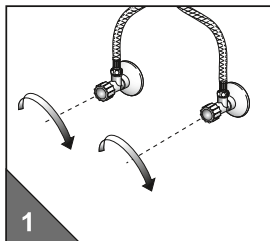



**Batteriewechsel**

**Changing the battery**

**Cambio batteria**

**Remplacer la pile**

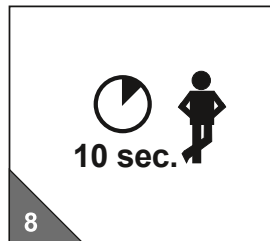
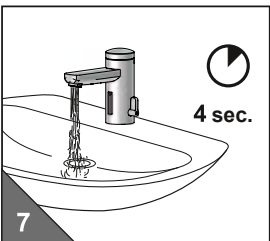
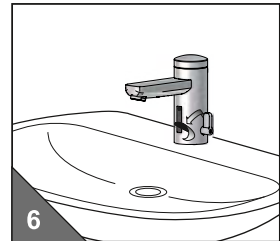
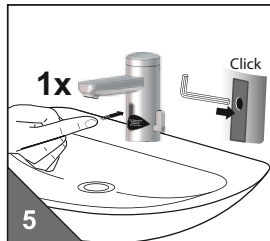
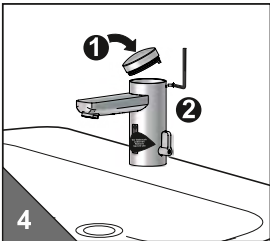
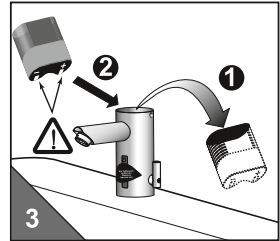
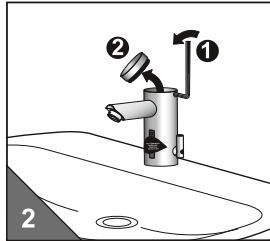
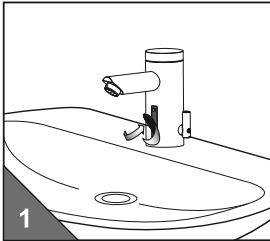

**Temperatur  
Fixeinstellung**

**Fixed temperature  
setting**

**Temperatura  
impostazione fissa**

**Réglage fixe de la  
température**

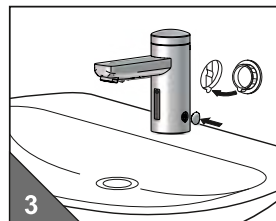
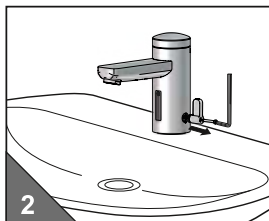
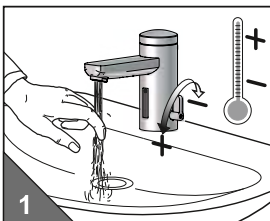



12.696.061.000

12.696.071.000

12.696.151.000

12.696.161.000

12.696.081.000

12.696.091.000

12.696.171.000

12.696.181.000

**Störungsbehebung**   **Trouble shooting**   **Difetti di funzionamento**   **Elimination des perturbations**

Störung / Fehler	Mögliche Ursache	Behebung
Armatur spült nicht	<ul style="list-style-type: none"> <li>• „Kurz-Aus“ ist aktiviert</li> <li>• Absperrventil geschlossen bzw. Schmutzsieb verstopft</li> <li>• Batterie leer</li> <li>• Stromausfall / Netzteil defekt</li> </ul>	<ul style="list-style-type: none"> <li>• „Kurz-Aus“ beenden</li> <li>• Absperrventil öffnen bzw. Schmutzsieb reinigen</li> <li>• Batterie austauschen</li> <li>• Stromversorgung prüfen</li> </ul>
Armatur spült selbstständig (ohne Benutzung)	<ul style="list-style-type: none"> <li>• Reflexion an Gegenständen</li> </ul>	<ul style="list-style-type: none"> <li>• Automatische Einmessung</li> </ul>
Wasser fließt permanent	<ul style="list-style-type: none"> <li>• Ventil defekt</li> </ul>	<ul style="list-style-type: none"> <li>• Kundendienst kontaktieren</li> </ul>
Rote LED blinkt	<ul style="list-style-type: none"> <li>• Batterie leer</li> </ul>	<ul style="list-style-type: none"> <li>• Batterie austauschen</li> </ul>

Function	Cause	Solution
Valve does not flush	<ul style="list-style-type: none"> <li>• „Intermittent off“ is activated</li> <li>• Stop valve closed or filter clogged</li> <li>• Battery flat</li> <li>• Power failure</li> </ul>	<ul style="list-style-type: none"> <li>• End „intermittent off“</li> <li>• Open stop valve or clean filter</li> <li>• Change battery</li> <li>• Check power supply</li> </ul>
Valve flushes uncontrolled (without use)	<ul style="list-style-type: none"> <li>• Reflection</li> </ul>	<ul style="list-style-type: none"> <li>• Automatic sensor adjustment</li> </ul>
Water flows permanently	<ul style="list-style-type: none"> <li>• Valve defect</li> </ul>	<ul style="list-style-type: none"> <li>• Call Customer Service</li> </ul>
Red LED flashes	<ul style="list-style-type: none"> <li>• Battery flat</li> </ul>	<ul style="list-style-type: none"> <li>• Change battery</li> </ul>

Difetto / errore	Possibili cause	Soluzioni
L'orinatoio non sciacqua	<ul style="list-style-type: none"> <li>• „Arresto temporaneo“ attivato</li> <li>• Valvola d'intercettazione chiusa o filtro intasato</li> <li>• Batteria esaurita</li> <li>• Breve interruzione di corrente</li> </ul>	<ul style="list-style-type: none"> <li>• „Arresto temporaneo“ terminato</li> <li>• Aprire la valvola d'intercettazione o pulire il filtro</li> <li>• Cambiare la batteria</li> <li>• Verificare l'alimentazione elettrica</li> </ul>
L'orinatoio si attiva autonomamente (senza essere stato usato)	<ul style="list-style-type: none"> <li>• Riflesso</li> </ul>	<ul style="list-style-type: none"> <li>• Misurazione automatica</li> </ul>
L'acqua scorre continuamente	<ul style="list-style-type: none"> <li>• Valvola difettosa</li> </ul>	<ul style="list-style-type: none"> <li>• Servizio Assistenza</li> </ul>
LED rosso lampeggia	<ul style="list-style-type: none"> <li>• Batteria esaurita</li> </ul>	<ul style="list-style-type: none"> <li>• Cambiare la batteria</li> </ul>

Perturbation / Erreur	Cause possible	Solution
Aucun déclenchement	<ul style="list-style-type: none"> <li>• «Arrêt bref» activé</li> <li>• Soupape d'arrêt fermée ou tamis bouché</li> <li>• Pile usée</li> <li>• Panne de courant</li> </ul>	<ul style="list-style-type: none"> <li>• Terminer «Arrêt bref»</li> <li>• Ouvrir la soupape d'arrêt ou nettoyer le tamis</li> <li>• Remplacer la pile</li> <li>• Contrôler l'alimentation en courant</li> </ul>
L'eau coule d'elle-même (sans que l'urinoir soit utilisé)	<ul style="list-style-type: none"> <li>• Reflet</li> </ul>	<ul style="list-style-type: none"> <li>• Réglage automatique de la cellule</li> </ul>
L'eau coule en permanence la cellule LED clignote	<ul style="list-style-type: none"> <li>• Soupape défectueuse</li> </ul>	<ul style="list-style-type: none"> <li>• Contacter le service après-vente</li> </ul>
	<ul style="list-style-type: none"> <li>• Pile utilisé</li> </ul>	<ul style="list-style-type: none"> <li>• Remplacer la pile</li> </ul>

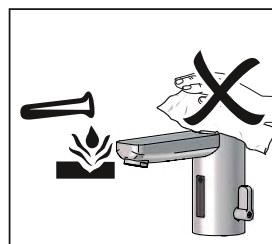
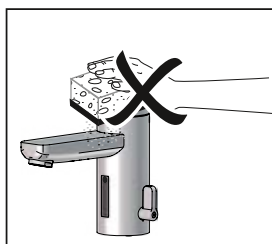
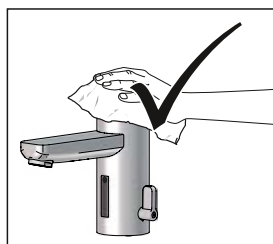
**Pflege****Maintenance****Cura****Entretien holdelse**

**Technische Daten****Technical Data****Dati tecnici****Données techniques**

Batteriebetrieb	battery operation	Funzionamento a batterie	Fonctionnement sur batterie	<b>6 VDC</b>
Netzbetrieb	mains supply	Funzionamento con alimentazione di rete	Fonctionnement sur secteur	<b>100-240 VAC / 6 VDC</b>
Wassernachlaufzeit	follow up time	Tempo di coda dell'acqua	Post-écoulement de l'eau	<b>1–10 sec.</b>
Wasserlaufzeit: Dauer - Ein und 12/24/48h Hygiene- spülung	Time of water flow: Continuous "On" and 12/24/48h automa- tic flush	Tempo di apertura: Possibilità di portata permanente e risciacquo igienico per 12/24/48 h	Écoulement continu: Durée d'écoulement de l'eau et rinçage hygiénique de 12/24/48 h	<b>0,5–20 min.</b>
Leistungsaufnahme Standby L10 / L20 / L30	Standby Power L10 / L20 / L30	Potenza assorbita in standby L10 / L20 / L30	Puissance absorbée en veille L10 / L20 / L30	<b>&lt; 0,3 W</b>



### Richtlinien zur Installation

- Wasserleitungsdrücke von Warmwasser und Kaltwasser müssen gleich sein.
- Installation und Lagerung nur in frostsicheren Räumen.
- Ab Datum des Erwerbes (Kaufbeleg) gewähren wir eine Garantie von 2 Jahren.

### Installation guidelines

- The water pressure for both the hot and cold water pipes should be equal.
- Install and store in frost-proof rooms only.
- We will guarantee the products for 2 years from the date of acquisition.

### Direttiva per l'installazione

- Si prega di osservare le norme esistenti per l'installazione e l'allacciamento all'impianto idrico.
- Si consiglia l'installazione con pressioni dell'acqua calde e fredde equilibrate.
- Garantiamo il prodotto per 2 anni dalla data di acquisto.

### Directives d'installation

- Respecter les normes en vigueur et les conditions de raccordement au réseau d'eau local.
- L'eau chaude et l'eau froide doivent avoir la même pression.
- Nous accordons une garantie de 2 ans sur les produits à partir de la date d'achat (ticket de caisse).

### Installation

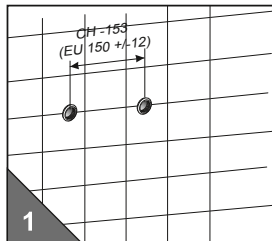

### Installation

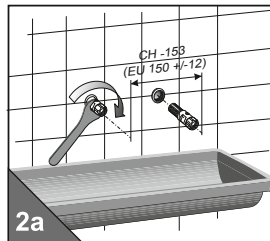

### Installazione

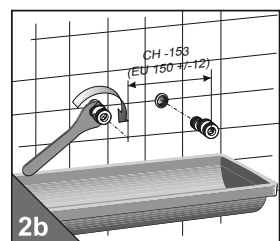

### Installation

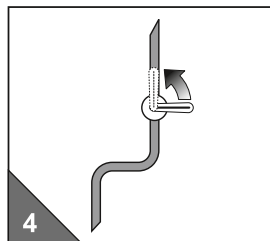
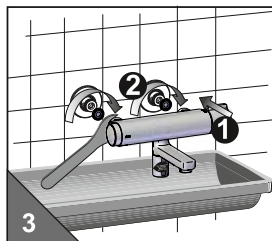



## Inbetriebnahme

## Preparing for operation

## Messa in funzione

## Mise en service

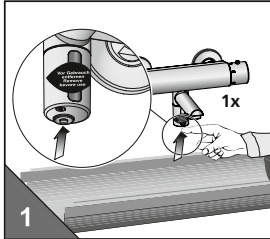

1x Taste drücken...  
Aufkleber entfernen...

Press the key once...  
remove sticker...

Premere il tasto 1x... rimuovere  
adesivo...

Appuyez 1x sur la touche...  
retirez l'autocollant...

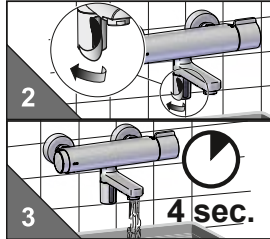

...Wasser fließt ca. 4 sec....

...water flows for approx. 4 sec....

...l'acqua scorre per  
ca. 4 sec...

...l'eau coule env. 4 sec....

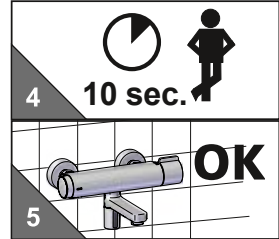

...10 sec. warten – betriebsbereit

...wait 10 sec. –  
ready for use

...attendre 10 sec. –  
pronto per il servizio

...attendez 10 sec. – opérationnel

## Funktionen

## Funcions

## Funzioni

## Fonctions

- Wasser „Ein“
- Water flow „On“
- Flusso aperto
- Ecoulement ouvert

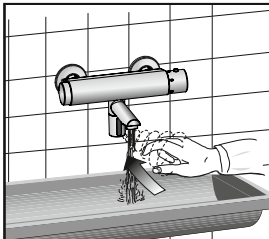

- Wasser „Aus“
- Water flow „Off“
- Flusso chiuso
- Ecoulement fermé

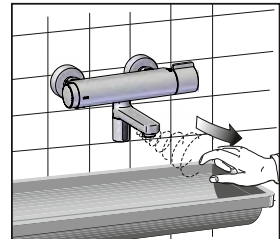

## Temperatur-einstellung

## Adjusting the temperature

## Impostazione della temperatura

## Réglage de la température

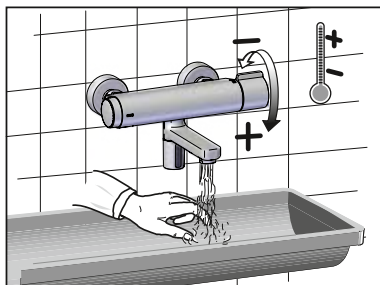



11.692.083.000  
11.692.093.000 INT

### iqua-Klick (Komfort-Taste)

- Dauer Ein
- Continuous On
- Continou On
- Ecoulement continu

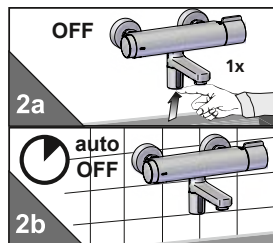
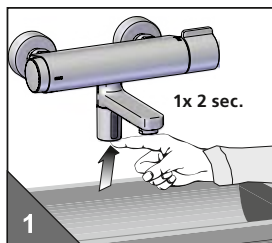

- „Kurz Aus“
- „Intermittent Off“
- Possibilità di interruzione del funzionamento
- Interruption brève

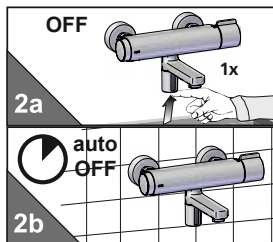
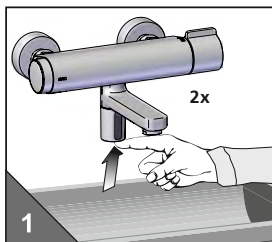

### Wassernachlaufzeit einstellen

### Changing Time of water flow

### Impostare il tempo di coda dell'acqua

### Réglage du post- écoulement de l'eau

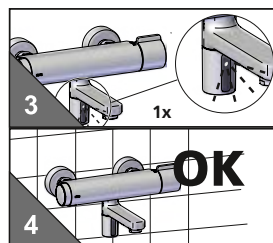
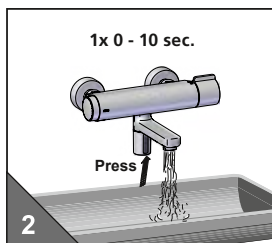
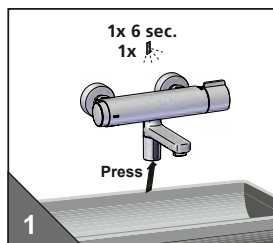

- Taste 6 sec. drücken, loslassen ...
- Press the key for approx. 6 sec. release...
- Premere il tasto per ca. 6 sec., poi rilasciarlo...
- Appuyez pendant env. 6 sec. sur la touche, relâchez...

- ...erneut drücken, Wasser „EIN“, 1 sec. - 10 sec. gedrückt halten, loslassen
- ...press again. Hold down water „ON“ for 1 sec. - 10 sec. release.
- ...premere nuovamente, tenere premuto acqua „ON“ per 1 sec. - 10 sec., poi rilasciarlo
- ...appuyez à nouveau, „Ecoulement ouvert“, tenez la touche enfoncée 1 sec. - 10 sec., relâchez





**Wasserlaufzeit:  
„Dauer-Ein“ und  
„12/24/48 Stunden  
Hygienespülung“**

- Wasserlaufzeit:  
„12/24/48 Stunden  
Hygienespülung“  
entspricht „Dauer-Ein“

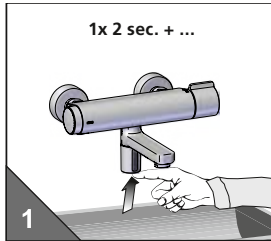

- Taste 2 sec. drücken,  
loslassen...
- Press the key for 2 sec. Release...
- Premere il tasto per 2 sec.,  
poi rilasciarlo...
- Appuyez pendant 2 sec.  
sur la touche, relâchez...

**Water flow duration: Durata acqua:  
„Continuous On“ and  
„12/24/48 hours  
automatic flush“**

- Water flow duration:  
„12/24/48 hours  
automatic flush“ equates  
to „Continuous On“
- Durata acqua:  
„Scarico forzato ogni  
12/24/48 ore“ equivale a  
„Continuo On“

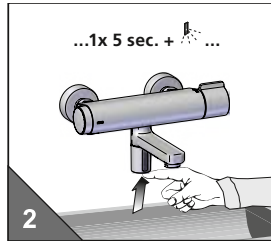

- ...erneut drücken und gedrückt  
halten ...
- ...press again and hold down...
- ...premere nuovamente e tenere  
premuta...
- ...appuyez à nouveau et tenez la  
touche enfoncée ...

**Période de l'eau:  
„Ecoulement Continu“  
e „Rinçage forcé  
12/24/48 heures“**

- Période de l'eau:  
„Rinçage forcé 12/24/48  
heures“ équivaut à  
„Ecoulement Continu“

...1x		= 0,5 min.
...2x		= 1,0 min.
...3x		= 1,5 min.
...	...	...
...38x		= 19,0 min.
...39x		= 19,5 min.
...40x		= 20,0 min.

- ...nach gewünschter Laufzeit  
loslassen.
- ...release after the required flow  
duration.
- ...rilasciare dopo il tempo di scorri-  
mento desiderato.
- ...relâchez après la durée souhaitée.

**12/24/48 Stunden  
Hygienespülung**

- Wasserlaufzeit:  
„12/24/48 Stunden  
Hygienespülung“  
entspricht „Dauer-Ein“

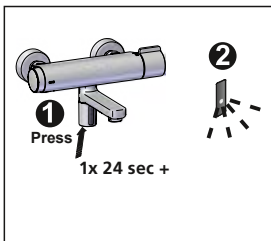

- 1x 24 sec. Taste drücken bis...
- Press key 1x 24 sec. until...
- Premere il tasto brevemente  
1x 24 sec. finché...
- Appuyez pendant env. 1x 24 sec. sur  
la touche jusqu'à ce que...

**12/24/48 hours  
automatic flush**

- Water flow duration:  
„12/24/48 hours  
automatic flush“ equates  
to „Continuous On“

**Scarico forzato  
ogni 12/24/48 ore**

- Durata acqua:  
„Scarico forzato ogni  
12/24/48 ore“ equivale a  
„Continuo On“

**Rinçage forcé  
12/24/48 heures**

- Période de l'eau:  
„Rinçage forcé 12/24/48  
heures“ équivaut à  
„Ecoulement Continu“

			<b>h</b>
- deaktivieren - disattivare	- deactivate - désactiver	1x	----
- aktivieren - attivare	- activate - activer	2x	12 h
		3x	24 h
		4x	48 h

- ...LED 1 - 4x blinkt -  
Taste loslassen...
- ...LED flashes 1 - 4x - release...
- ...il LED non lampeggia  
1 - 4x - rilasciare...
- ...la LED clignote  
1 - 4x - relâchez...
- ...betriebsbereit
- ...ready for use
- ...pronto per il servizio
- ...opérationnel



11.692.083.000  
11.692.093.000 INT

### Automatische Sensoreinmessung

### Automatic sensor adjustment

### Misurazione automatica

### Réglage automatique de la cellule

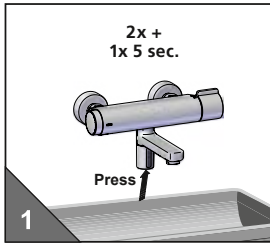

- 2x kurz und 1x 5 sec. Taste drücken bis...
- Press key twice, press again and hold down for app. 5 sec. until...
- Premere il tasto brevemente 2x e 1x per 5 sec. finché...
- Appuyez 2x brièvement et x1 pendant 5 sec. sur la touche jusqu'à ce que...

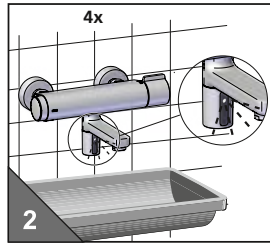

- ...LED 4x blinkt - Taste loslassen...
- ...LED flashes 4x. Release...
- ...il LED lampeggia 4x - rilasciare...
- ...la DEL clignote 4x - relâchez...



- ...15 sec. warten...
- ...wait 15 sec.
- ...attendre 15 sec.

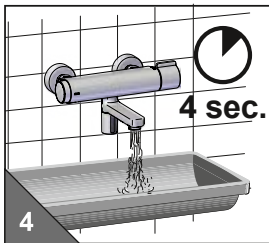

- ...Wasser fließt ca. 4 sec....
- ...Water flows for approx. 4 sec....
- ...L'acqua scorre per ca. 4 sec...
- ...L'eau coule env. 4 sec....

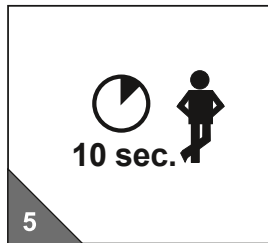

- ...10 sec. warten...
- ...wait 10 sec....
- ...attendere 10 sec....
- ...attendez 10 sec....

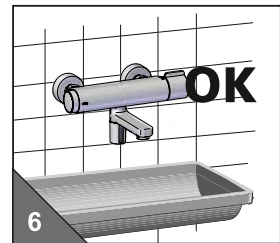

- ...betriebsbereit
- ...ready for use
- ...pronto per il servizio
- ...opérationnel



## Einstellung der Sensorreichweite

## Setting the sensor range

## Impostazione della portata del sensore

## Réglage de la portée du détecteur

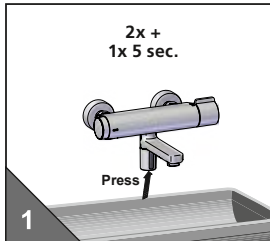

- 2x kurz und 1x 5 sec. Taste drücken bis...
- Press key twice, press again and hold down for app. 5 sec. until...
- Premere il tasto brevemente 2x e 1x per 5 sec. finché...
- Appuyez 2x brièvement et 1x pendant 5 sec. sur la touche jusqu'à ce que...

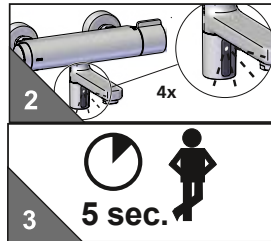

...LED 4x blinkt - Taste gedrückt halten...

...LED flashes 4x - hold pressed...

...il LED lampeggia 4x - e tenere premuto...

...la LED clignote 4x - et tenez la touche enfoncée...

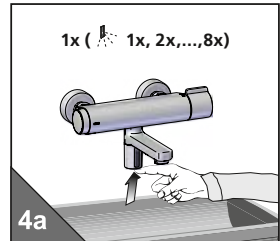

...Taste drücken bis LED blinkt...

...hold down the key until the LED flashes...

...premere il tasto finché il LED lampeggia...

...appuyez sur la touche jusqu'à ce que la LED clignote...

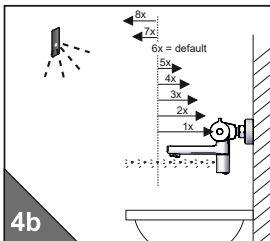

LED blinkt: 1x = min...  
8x = max., loslassen

LED flashes: 1x = min...  
8x = max., release

LED lampeggia: 1x = min...  
8x = max., rilasciare

LED clignote: 1x = min...  
8x = max., relâchez

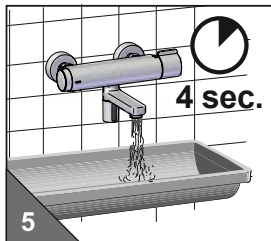

...Wasser fließt ca. 4 sec....

...water flows for approx. 4 sec....

...l'acqua scorre per ca. 4 sec....

...l'eau coule env. 4 sec....

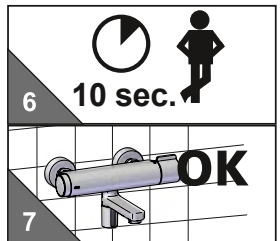

...10 sec. warten - betriebsbereit

...wait 10 sec., ready for use

...attendere 10 sec. - pronto per il servizio

...attendez 10 sec. - opérationnel



**Schmutz-  
sieb-  
Reinigung**

**Cleaning the filters Pulire il filtro**

**Nettoyage du tamis**

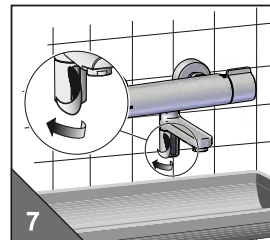
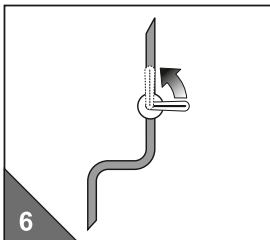
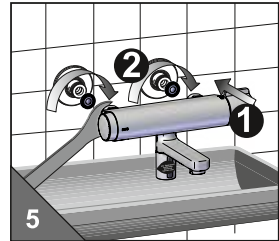
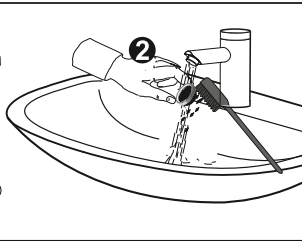
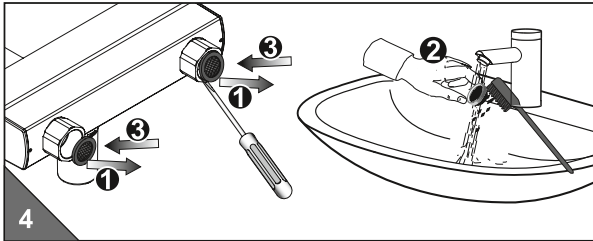
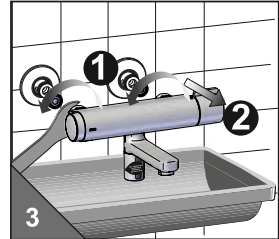
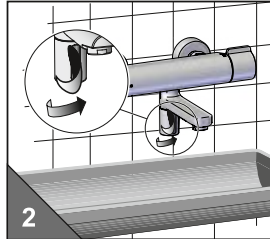
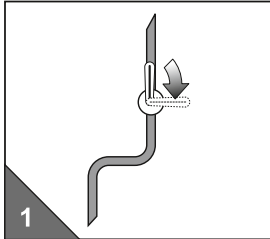



**Batteriewechsel**

**Changing  
the battery**

**Cambio batteria**

**Remplacer la pile**

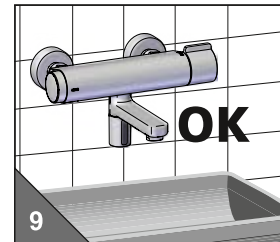
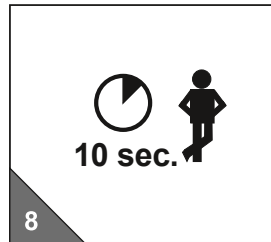
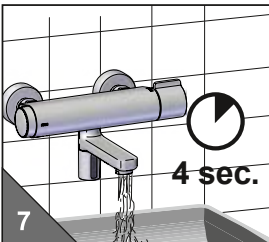
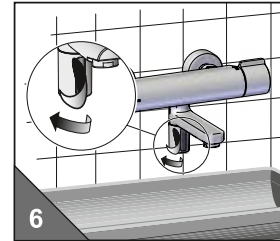
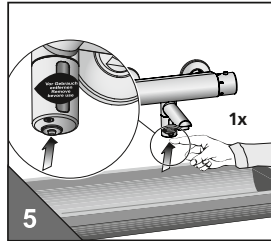
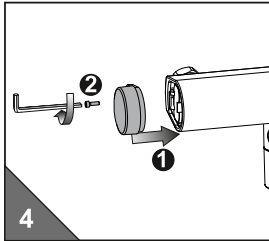
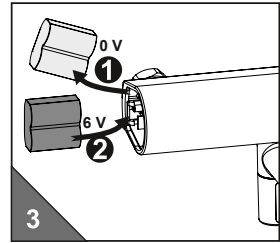
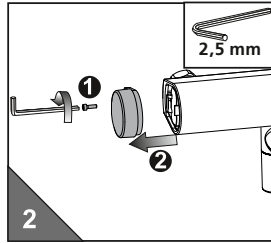
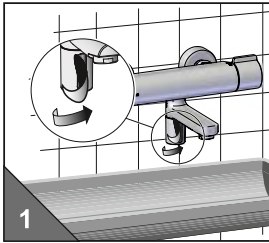



**Störungsbehebung** **Trouble shooting** **Difetti di funzionamento** **Elimination des perturbations**

Störung / Fehler	Mögliche Ursache	Behebung
Armatur spült nicht	<ul style="list-style-type: none"> <li>• „Kurz-Aus“ ist aktiviert</li> <li>• Absperrventil geschlossen bzw. Schmutzsieb verstopft</li> <li>• Batterie leer</li> <li>• Stromausfall / Netzteil defekt</li> </ul>	<ul style="list-style-type: none"> <li>• „Kurz-Aus“ beenden</li> <li>• Absperrventil öffnen bzw. Schmutzsieb reinigen</li> <li>• Batterie austauschen</li> <li>• Stromversorgung prüfen</li> </ul>
Armatur spült selbstständig (ohne Benutzung)	<ul style="list-style-type: none"> <li>• Reflexion an Gegenständen</li> </ul>	<ul style="list-style-type: none"> <li>• Automatische Einmessung</li> </ul>
Wasser fließt permanent	<ul style="list-style-type: none"> <li>• Ventil defekt</li> </ul>	<ul style="list-style-type: none"> <li>• Kundendienst kontaktieren</li> </ul>
Rote LED blinkt	<ul style="list-style-type: none"> <li>• Batterie leer</li> </ul>	<ul style="list-style-type: none"> <li>• Batterie austauschen</li> </ul>

Function	Cause	Solution
Valve does not flush	<ul style="list-style-type: none"> <li>• „Intermittent off“ is activated</li> <li>• Stop valve closed or filter clogged</li> <li>• Battery flat</li> <li>• Power failure</li> </ul>	<ul style="list-style-type: none"> <li>• End „intermittent off“</li> <li>• Open stop valve or clean filter</li> <li>• Change battery</li> <li>• Check power supply</li> </ul>
Valve flushes uncontrolled (without use)	<ul style="list-style-type: none"> <li>• Reflection</li> </ul>	<ul style="list-style-type: none"> <li>• Automatic sensor adjustment</li> </ul>
Water flows permanently	<ul style="list-style-type: none"> <li>• Valve defect</li> </ul>	<ul style="list-style-type: none"> <li>• Call Customer Service</li> </ul>
Red LED flashes	<ul style="list-style-type: none"> <li>• Battery flat</li> </ul>	<ul style="list-style-type: none"> <li>• Change battery</li> </ul>

Difetto / errore	Possibili cause	Soluzioni
L'orinatoio non sciacqua	<ul style="list-style-type: none"> <li>• „Arresto temporaneo“ attivato</li> <li>• Valvola d'intercettazione chiusa o filtro intasato</li> <li>• Batteria esaurita</li> <li>• Breve interruzione di corrente</li> </ul>	<ul style="list-style-type: none"> <li>• „Arresto temporaneo“ terminato</li> <li>• Aprire la valvola d'intercettazione o pulire il filtro</li> <li>• Cambiare la batteria</li> <li>• Verificare l'alimentazione elettrica</li> </ul>
L'orinatoio si attiva autonomamente (senza essere stato usato)	<ul style="list-style-type: none"> <li>• Riflesso</li> </ul>	<ul style="list-style-type: none"> <li>• Misurazione automatica</li> </ul>
L'acqua scorre continuamente	<ul style="list-style-type: none"> <li>• Valvola difettosa</li> </ul>	<ul style="list-style-type: none"> <li>• Servizio Assistenza</li> </ul>
LED rosso lampeggia	<ul style="list-style-type: none"> <li>• Batteria esaurita</li> </ul>	<ul style="list-style-type: none"> <li>• Cambiare la batteria</li> </ul>

Perturbation / Erreur	Cause possible	Solution
Aucun déclenchement	<ul style="list-style-type: none"> <li>• «Arrêt bref» activé</li> <li>• Soupape d'arrêt fermée ou tamis bouché</li> <li>• Pile usée</li> <li>• Panne de courant</li> </ul>	<ul style="list-style-type: none"> <li>• Terminer «Arrêt bref»</li> <li>• Ouvrir la soupape d'arrêt ou nettoyer le tamis</li> <li>• Remplacer la pile</li> <li>• Contrôler l'alimentation en courant</li> </ul>
L'eau coule d'elle-même (sans que l'urinoir soit utilisé)	<ul style="list-style-type: none"> <li>• Reflet</li> </ul>	<ul style="list-style-type: none"> <li>• Réglage automatique de la cellule</li> </ul>
L'eau coule en permanence la cellule LED clignote	<ul style="list-style-type: none"> <li>• Soupape défectueuse</li> <li>• Pile utilisé</li> </ul>	<ul style="list-style-type: none"> <li>• Contacter le service après-vente</li> <li>• Remplacer la pile</li> </ul>

**Pflege**

**Maintenance**

**Cura**

**Entretien holdelse**

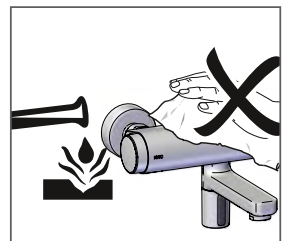
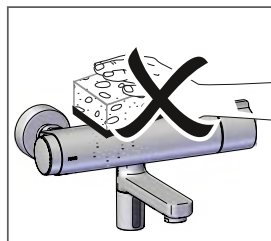
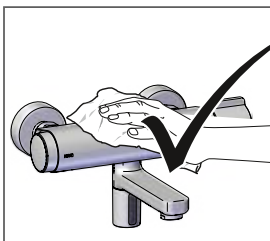



**Technische Daten      Technical Data      Dati tecnici      Données techniques**

Batteriebetrieb	Battery operation	Funzionamento a batterie	Fonctionnement sur batterie	6 VDC
Wassernachlaufzeit (Werkseinstellung)	Follow up time (factory setting)	Tempo di coda dell'acquaw (impostazione di fabbrica)	Post-écoulement de l'eau (réglage d'usine)	1 sec.
Wasserlaufzeit: „12/24/48 Stunden Hygienespülung“ entspricht „Dauer-Ein“	Water flow duration: „12/24/48 hours automatic flush“ equates to „Continous On“	Durata acqua: „Scarico forzato ogni 12/24/48 ore“ equivale a „Continuo On“	Période de l'eau: „Rinçage forcé 12/24/48 heures“ équivalent à „Ecoule- ment Continu“	0,5–20 min.



### Installation

The product may only be installed by a qualified plumber.

Observe the local installation regulations and any country specific standards at all time.

### Operating Data

Ideal operating pressure	3 bar
Maximum operating pressure	5 bar
Minimum operating pressure	1 bar
Equal pressure is recommended	

Ideal water temperature	60°C
Maximum water temperature	70°C

### Environmental conditions

No cleaning agents or chemicals should be stored in the immediate vicinity of faucets and connection hoses.

Leaking vapors can damage the faucet and connection hoses.

### Spare Parts

Only original spare parts may be used.



### Flush Pipes

Flush the pipes according to the applicable standards before mounting the faucet.



### General Cleaning Instructions

Faucet surface must be of room temperature before cleaning. Evaluated temperature increases damage of the surface. Cleaning instructions of the detergent manufacturer must be followed.

#### - Maintenance

Rub the faucet daily dry with a soft cloth. Never use corrosive cleaners or cleaning pads.

#### - Cleaning

Dirt or calcium deposits on the faucet surface must be removed with soft detergent or with soap water. Rinse well with water immediately after cleaning, until all detergent is removed from the surface. Dry with soft cloth.



### Periodic Checks

For safety reasons, the connection and shower hoses must be checked periodically for the following:

#### - Watertightness

Damp or dripping hoses must be replaced.

#### - Corrosion

Hoses with rusty or oxidized surfaces must be replaced.

#### - Mechanical damage

Hoses that show signs of mechanical damage must be replaced.





### Installation

Die Produkte dürfen nur durch ausgebildete Sanitär-Installateure montiert werden.

Die lokalen Richtlinien, Vorschriften und Normen müssen eingehalten werden.

### Betriebsdaten

Idealer Betriebsdruck	3 bar
Maximaler Betriebsdruck	5 bar
Minimaler Betriebsdruck	1 bar
Druckgleichheit empfehlenswert	

Ideale Wassertemperatur	60°C
Maximale Wassertemperatur	70°C

### Umgebungsbedingungen

In unmittelbarer Nähe von Armaturen und Anschlusschläuchen dürfen keine Reinigungsmittel und Chemikalien gelagert werden.

Austretende Dämpfe können die Armatur und die Anschlusschläuche beschädigen.

### Ersatzteile

Es dürfen ausschliesslich Original-Ersatzteile verwendet werden.



### Leitungen spülen

Vor der Montage der Armatur müssen die Leitungen nach gültigen Normen gespült werden.



### Grundsätzliche Reinigungshinweise

Beim Reinigen muss die Oberfläche der Armatur kalt sein. Wärme beschleunigt die Zerstörung der Oberfläche. Reinigungshinweise der Reinigungsmittelhersteller beachten.

#### - Pflege

Armatur täglich mit weichem Lappen trocken reiben. Scheuernde Reinigungsmittel und Putzschwämme unbedingt vermeiden.

#### - Reinigung

Schmutz- oder Kalkflecken auf der Armaturenoberfläche nur mit mildem Reinigungsmittel entfernen. Sofort nach dem Reinigen alle Reinigungsmittelrückstände mit kaltem Wasser wegspülen. Mit weichem Lappen trocken reiben.



### Periodische Kontrolle

Die Anschluss- und Brausenschläuche müssen aus Sicherheitsgründen periodisch auf folgende Punkte kontrolliert werden:

#### - Dichtheit

Feuchte oder tropfende Schläuche müssen ersetzt werden.

#### - Korrosionsschäden

Schläuche mit rostiger oder oxidiertes Oberfläche müssen ersetzt werden.

#### - Mechanische Beschädigung

Schläuche, welche eine mechanische Beschädigung aufweisen, müssen ersetzt werden.



### Installation

Le produit peut être installé seulement par un plombier qualifié.

Respecter à tout moment les directives d'installation locales ainsi que les normes spécifiques à chaque pays.

### Données de fonctionnement

Pression de service idéale	3 bars
Pression de service maximale	5 bars
Pression de service minimale	1 bar
Une pression égale est recommandée	

Température idéale de l'eau	60°C
Température maximale de l'eau	70°C

### Conditions environnementales

Aucun produit de nettoyage ni produit chimique ne doit être stocké à proximité immédiate des robinets et tuyaux de raccordement.

Les émanations de vapeurs peuvent endommager le robinet et les tuyaux de raccordement.

### Pièces de rechange

Seules des pièces de rechange d'origine peuvent être utilisées.



### Effectuer une vidange

Effectuer une vidange des tuyaux conformément aux normes applicables avant de monter le robinet.



### Instructions générales de nettoyage

La surface du robinet doit être à température ambiante avant nettoyage. Une température élevée augmente le risque d'endommager la surface. Les instructions de nettoyage du fabricant du détergent doivent être respectées.

#### - Maintenance

Essuyer quotidiennement le robinet avec un chiffon doux et sec.  
Ne jamais utiliser de nettoyants corrosifs ni de tampons nettoyants.

#### - Nettoyage

Les salissures ou les dépôts calcaires sur la surface du robinet doivent être éliminés à l'aide d'un détergent doux ou d'eau savonneuse. Bien rincer à l'eau immédiatement après avoir nettoyé, jusqu'à ce que tout résidu de détergent soit totalement éliminé de la surface. Sécher avec un chiffon doux.



### Contrôles périodiques

Pour des raisons de sécurité, les tuyaux de raccordement et de la douche doivent être contrôlés périodiquement quant à :

#### - L'étanchéité

Des tuyaux humides ou qui fuient doivent être remplacés.

#### - La corrosion

Des tuyaux avec une surface rouillée ou oxydée doivent être remplacés.

#### - Un dommage mécanique

Les tuyaux qui montrent des signes de dommage mécanique doivent être remplacés.



### Installazione

Il prodotto può essere installato solo da un idraulico qualificato.

Rispettare sempre le normative locali per l'installazione ed eventuali norme specifiche del Paese.

### Dati operativi

Pressione di funzionamento ideale	3 bar
Pressione di funzionamento massima	5 bar
Pressione di funzionamento minima	1 bar
Si raccomanda la stessa pressione	

Temperatura ideale dell'acqua	60°C
Temperatura massima dell'acqua	70°C

### Condizioni ambientali

Non conservare sostanze chimiche o agenti detergenti nelle immediate vicinanze di rubinetti e tubi flessibili di collegamento.

Le fuoriuscite di vapori possono danneggiare il rubinetto e i tubi flessibili di collegamento.

### Parti di ricambio

Utilizzare solo parti di ricambio originali.



### Lavaggio dei tubi

Prima di montare il rubinetto, lavare i tubi come previsto dalle norme vigenti.



### Istruzioni di pulizia generali

La superficie del rubinetto deve essere a temperatura ambiente prima di essere pulita. La temperatura elevata aumenta i danni alla superficie. Attenersi alle istruzioni per la pulizia del produttore del detergente.

#### - Manutenzione

Asciugare il rubinetto ogni giorno con un panno morbido.  
Non usare detergenti corrosivi o pagliette per la pulizia.

#### - Pulizia

Rimuovere sporcizia e depositi di calcare dalla superficie del rubinetto con un detergente delicato o acqua e sapone. Risciacquare bene con acqua subito dopo la pulizia, fino a rimuovere tutto il detergente dalla superficie. Asciugare con un panno morbido.



### Controlli periodici

Per motivi di sicurezza, è necessario controllare periodicamente i tubi flessibili di collegamento e della doccia per verificare quanto segue:

#### - Tenuta stagna

Sostituire i tubi flessibili che presentano umidità o perdite.

#### - Corrosione

Sostituire le superfici ossidate o arrugginite.

#### - Danni meccanici

Sostituire i tubi flessibili con segni evidenti di danni meccanici.



**IQUA Design, Batterie,  
ohne Mischung**

**12.696.151.000**

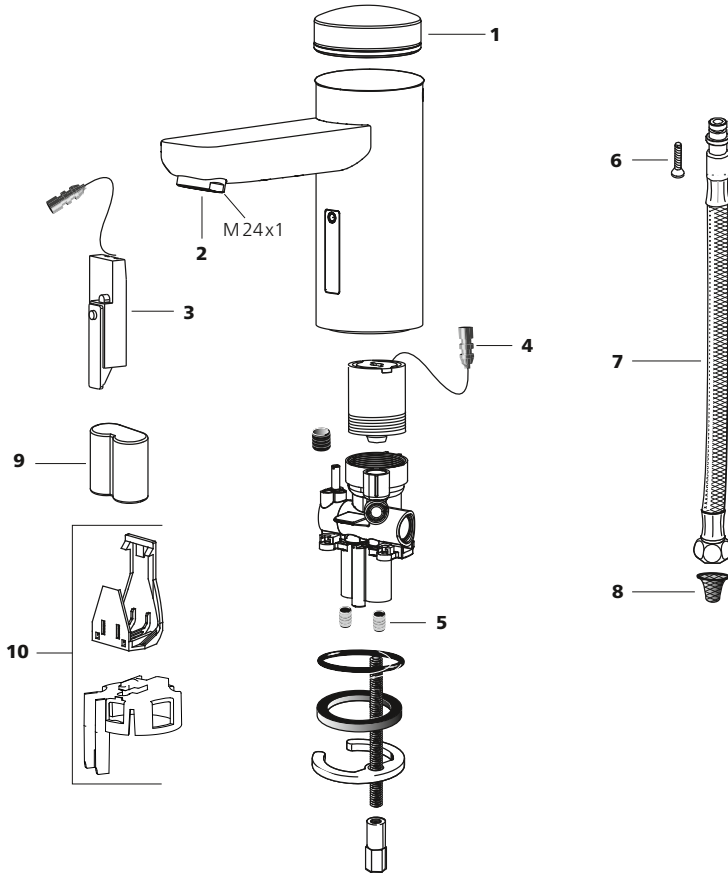

<b>1</b>	Z.538.744.000
<b>2</b>	Z.505.344.000
<b>3</b>	Z.534.316
<b>4</b>	Z.534.286
<b>5</b>	Z.501.993
<b>6</b>	Z.636.766
<b>7</b>	Z.536.784
<b>8</b>	Z.633.376
<b>9</b>	Z.534.309
<b>10</b>	Z.534.308



**12.696.161.000**

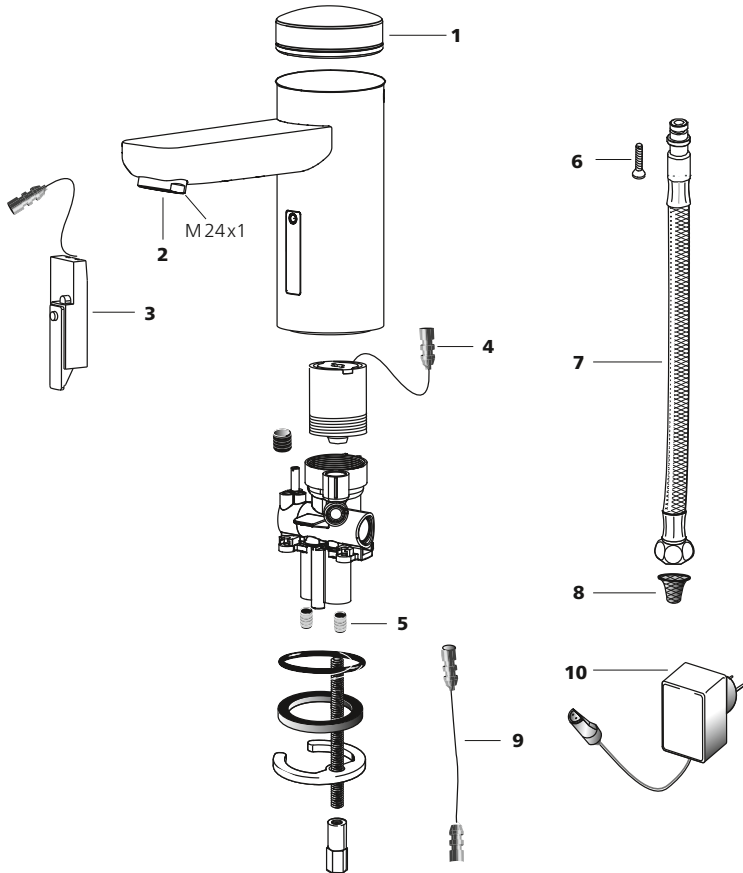

<b>1</b>	Z.538.744.000
<b>2</b>	Z.505.344.000
<b>3</b>	Z.534.317
<b>4</b>	Z.534.286
<b>5</b>	Z.501.993
<b>6</b>	Z.636.766
<b>7</b>	Z.536.784
<b>8</b>	Z.633.376
<b>9</b>	Z.534.285
<b>10</b>	Z.534.291



**12.696.061.000**

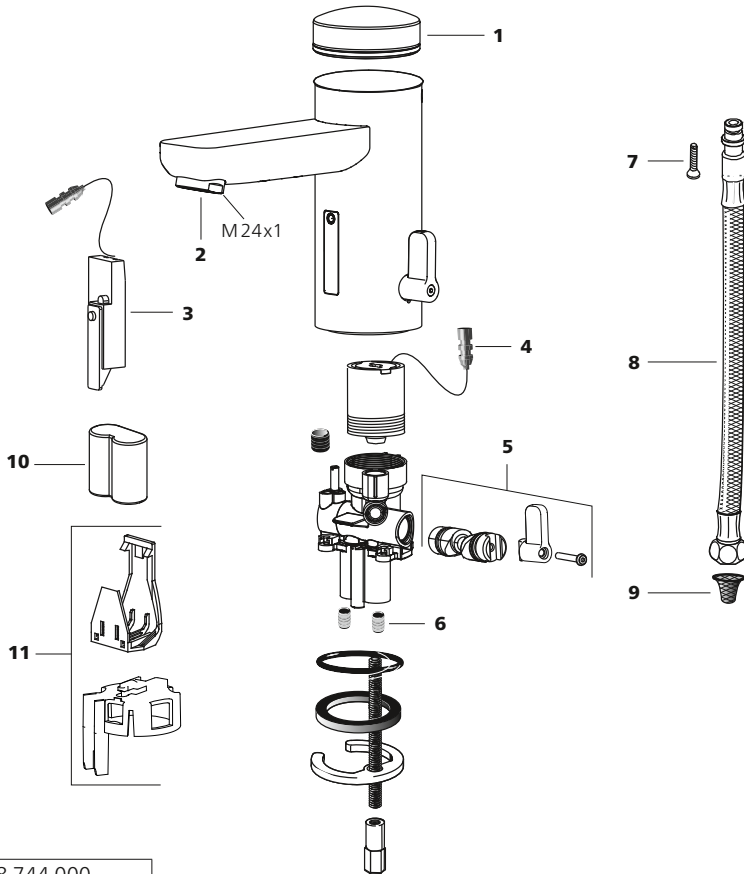

<b>1</b>	Z.538.744.000
<b>2</b>	Z.505.344.000
<b>3</b>	Z.534.316
<b>4</b>	Z.534.286
<b>5</b>	Z.538.745.000
<b>6</b>	Z.501.993
<b>7</b>	Z.636.766
<b>8</b>	Z.536.784
<b>9</b>	Z.633.376
<b>10</b>	Z.534.309
<b>11</b>	Z.534.308



**12.696.071.000**

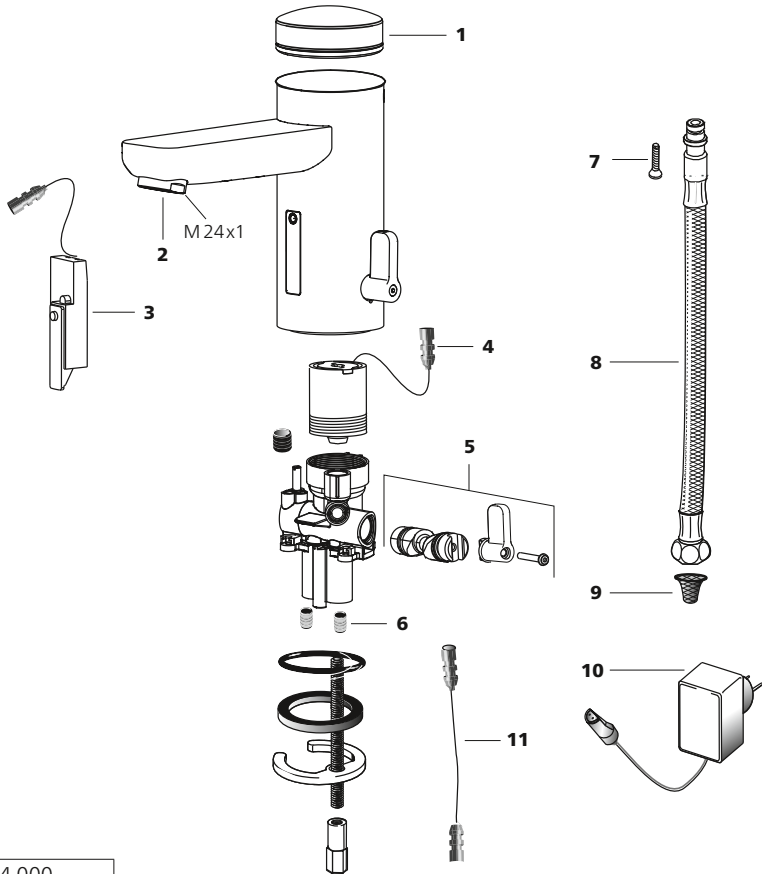

<b>1</b>	Z.538.744.000
<b>2</b>	Z.505.344.000
<b>3</b>	Z.534.317
<b>4</b>	Z.534.286
<b>5</b>	Z.538.745.000
<b>6</b>	Z.501.993
<b>7</b>	Z.636.766
<b>8</b>	Z.536.784
<b>9</b>	Z.633.376
<b>10</b>	Z.534.291
<b>11</b>	Z.534.285



**IQUA Style, Batterie,  
ohne Mischung**

**12.696.171.000**

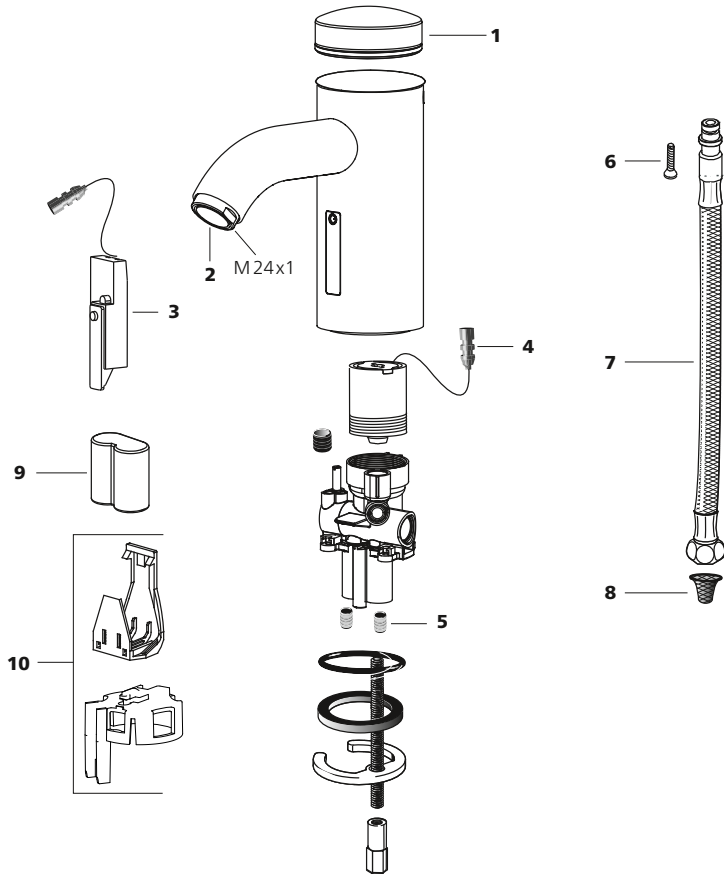

<b>1</b>	Z.538.744.000
<b>2</b>	Z.505.344.000
<b>3</b>	Z.534.316
<b>4</b>	Z.534.286
<b>5</b>	Z.501.993
<b>6</b>	Z.636.766
<b>7</b>	Z.536.784
<b>8</b>	Z.633.376
<b>9</b>	Z.534.309
<b>10</b>	Z.534.308





**IQUA Style, Netz,  
ohne Mischung**

**12.696.181.000**

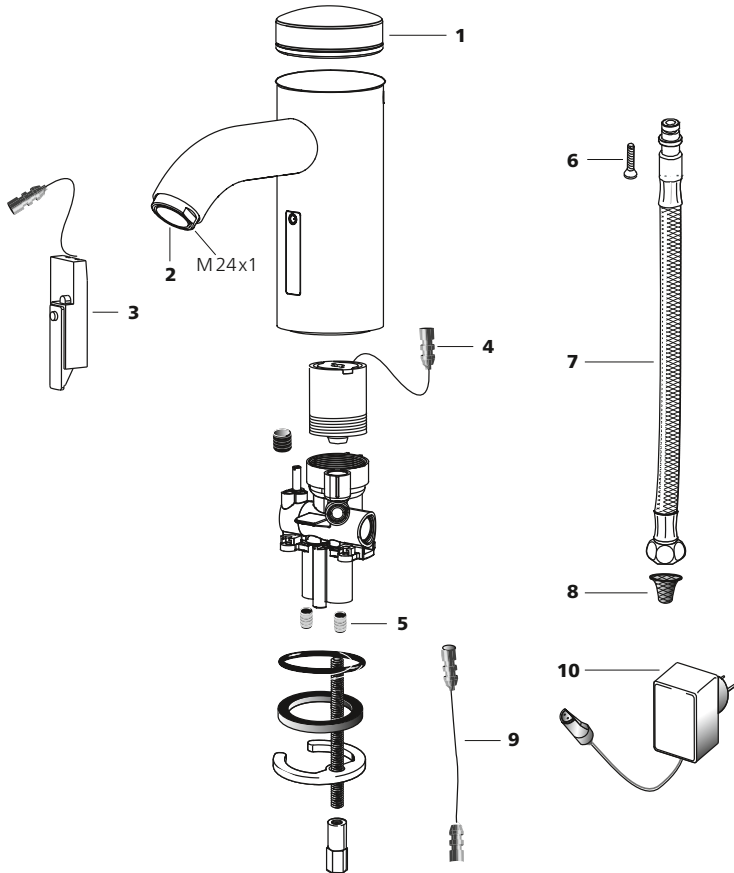

<b>1</b>	Z.538.744.000
<b>2</b>	Z.505.344.000
<b>3</b>	Z.534.317
<b>4</b>	Z.534.286
<b>5</b>	Z.501.993
<b>6</b>	Z.636.766
<b>7</b>	Z.536.784
<b>8</b>	Z.633.376
<b>9</b>	Z.534.285
<b>10</b>	Z.534.291



**IQUA Style, Batterie,  
mit Mischung**

**12.696.081.000**

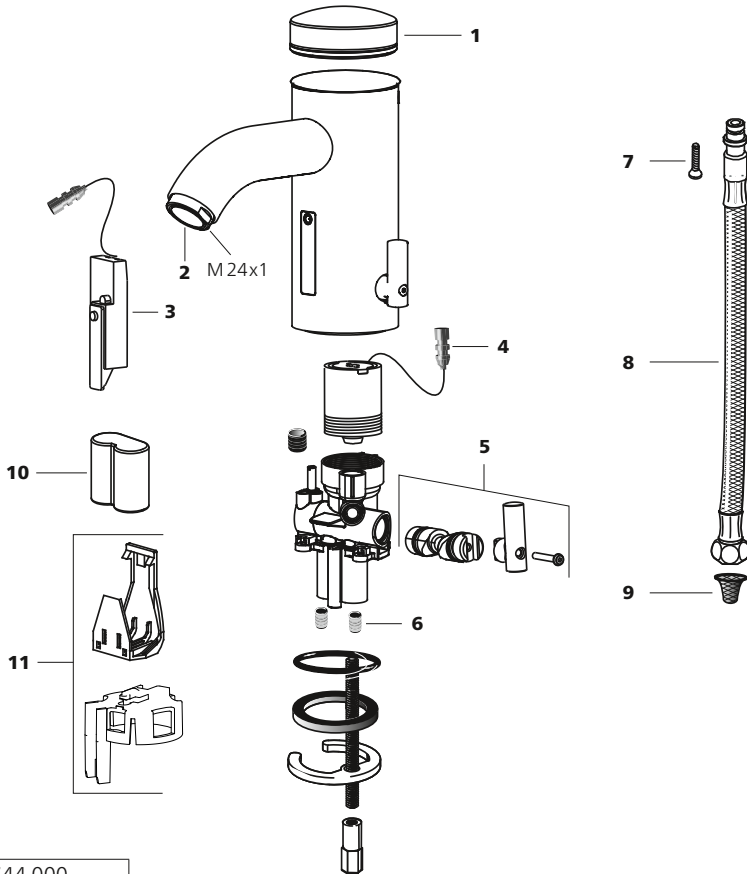

<b>1</b>	Z.538.744.000
<b>2</b>	Z.505.344.000
<b>3</b>	Z.534.316
<b>4</b>	Z.534.286
<b>5</b>	Z.534.318.000
<b>6</b>	Z.501.993
<b>7</b>	Z.636.766
<b>8</b>	Z.536.784
<b>9</b>	Z.633.376
<b>10</b>	Z.534.309
<b>11</b>	Z.534.308



**12.696.091.000**

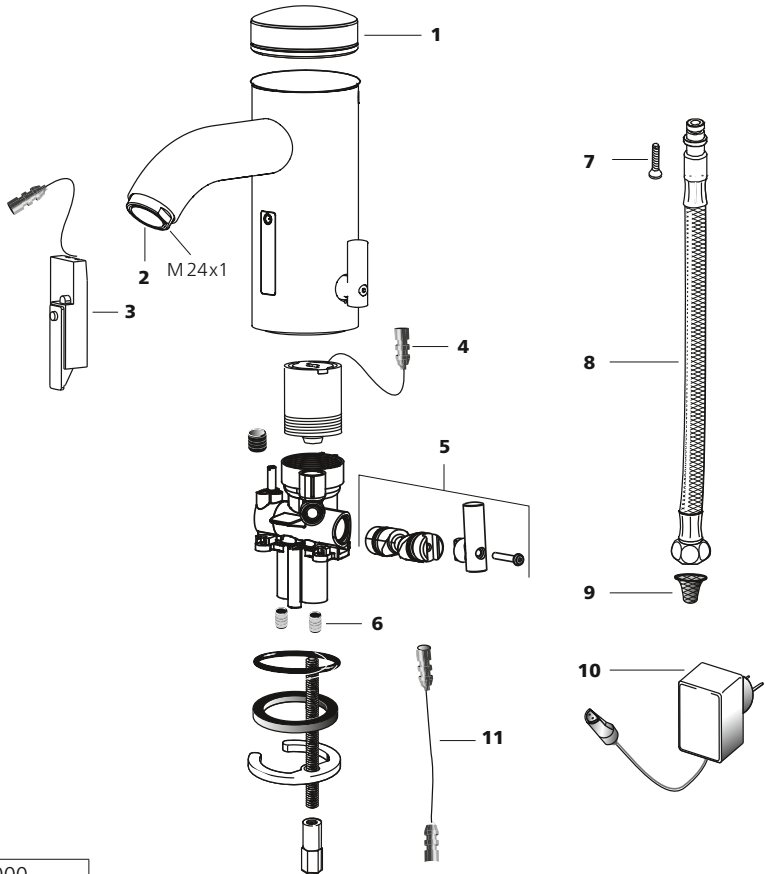

<b>1</b>	Z.538.744.000
<b>2</b>	Z.505.344.000
<b>3</b>	Z.534.317
<b>4</b>	Z.534.286
<b>5</b>	Z.534.318.000
<b>6</b>	Z.501.993
<b>7</b>	Z.636.766
<b>8</b>	Z.536.784
<b>9</b>	Z.633.376
<b>10</b>	Z.534.291
<b>11</b>	Z.534.285



11.692.083.000

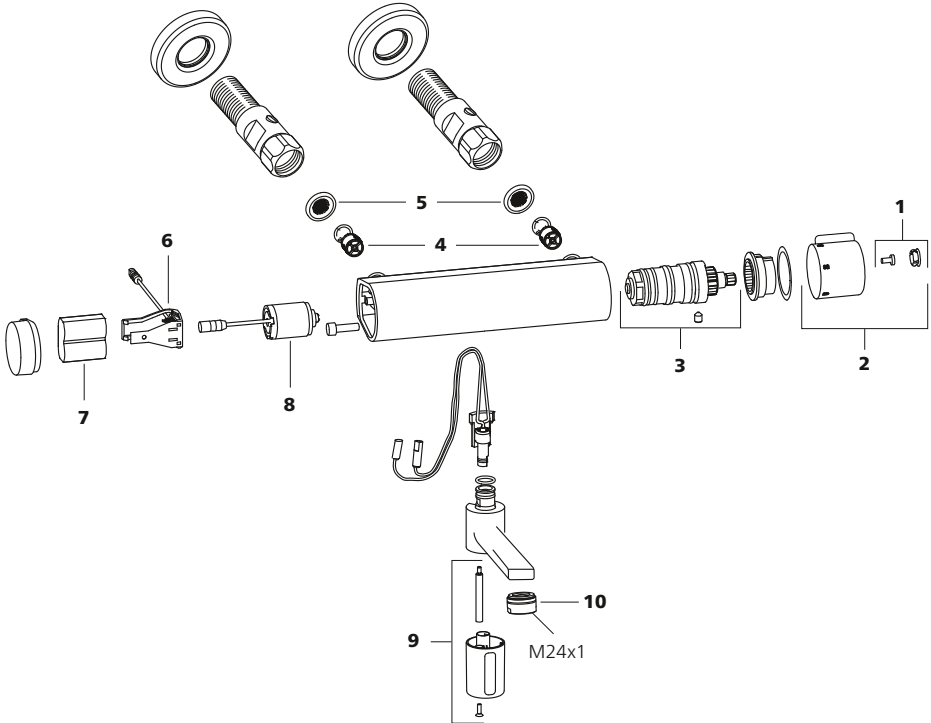

1	Z.537.373.000
2	Z.538.746.000
3	Z.536.836
4	Z.500.476
5	Z.636.938
6	Z.536.838
7	Z.534.309
8	Z.534.286
9	Z.536.835.000
10	Z.505.344.000



11.692.093.000 INT

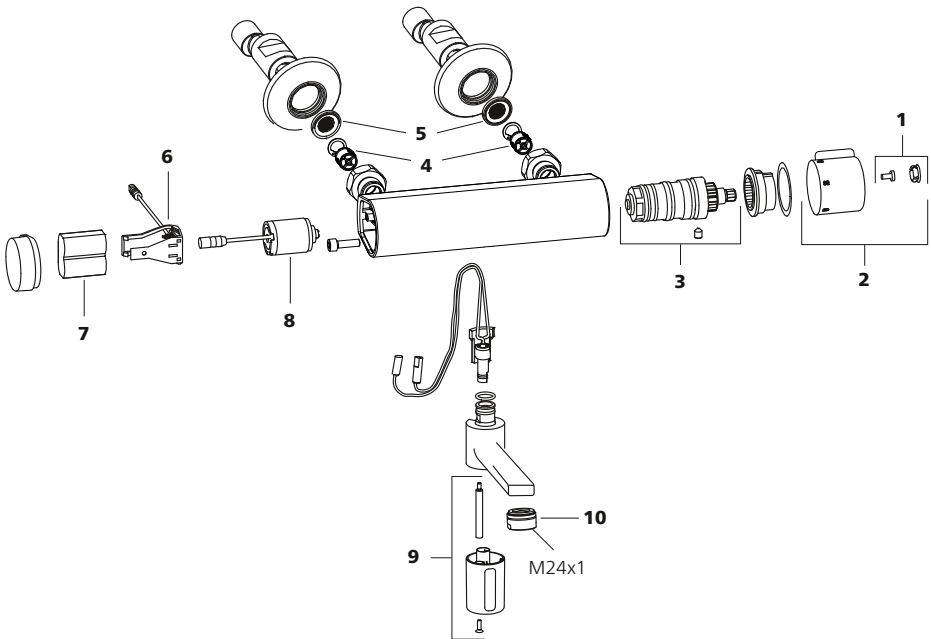

1	Z.537.373.000
2	Z.538.746.000
3	Z.536.836
4	Z.500.476
5	Z.636.938
6	Z.536.838
7	Z.534.309
8	Z.534.286
9	Z.536.835.000
10	Z.505.344.000





