

KWC WAMAS 2.0 Lever mixer - Basin

Modell-Linie: WAMAS 2.0 | 12.478.052.000FL
Taps | Manual taps

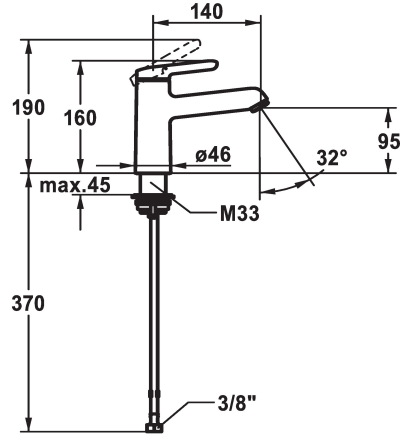

KWC-No.

125149
chromeline, A 140, flexible connection hoses, with pop-up valve

125150
chromeline, A 140, flexible connection hoses, without pop-up valve

- * Lever mixer
- * EcoProtect - water-saving device
- * Fixed spout
 - Neoperl® Perlator® SSR, swivelling jet regulator
- * KWC cartridge M 35 OP
- with ceramic discs

pop-up valve

with pop-up valve

without pop-up valve

- flow rate and temperature continuously variable
- temperature limitation
- * Flexible connection hoses 3/8"
- * QuickInstallation - Fastening via threaded connection with locking screws
- * Mounting hole size ø35 mm

Technical Data

Flow rate
pop-up valve
Connection
Spout
Handling
Color code
Installation type
Faucet_typ
Measure Height
Acoustic group
Projection A
Energy label
Dimension Water outlet
material

5 l/min (3 bar)
without pop-up valve
Flexible connection hoses
fixed
top lever
chromeline
Pillar installation
Lever mixer
160
I
A 140
A
95
Brass



Spare Parts

KWC WAMAS 2.0 Lever mixer - Basin

Modell-Linie: WAMAS 2.0 | 12.478.052.000FL
Taps | Manual taps



Cartridge M 35 OP

538331
Z.537.710
