

802158

Küchenmischer
Mitigeur de cuisine
Miscelatore da cucina
Mezclador de cocina
Kitchen faucet

KWC INOX KWC SUPRIMO

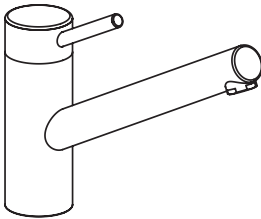

10.271.023.700
10.271.023.700FL

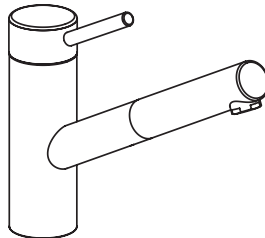

10.271.103.700
10.271.103.700FL

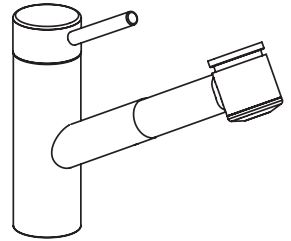

10.271.033.700
10.271.033.700FL
10.271.033.736
10.271.033.736FL

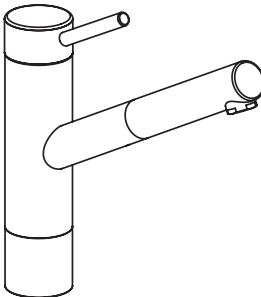

10.271.303.700
10.271.303.700FL

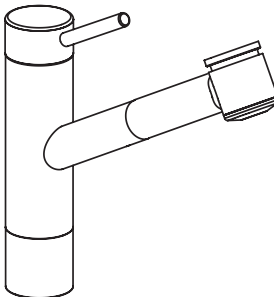

10.271.333.700
(USA only)

Betriebsdaten

Caractéristiques de fonctionnement

Caratteristiche di funzionamento

Datos de servicio

Operating data

Idealer Betriebsdruck : 3 bar
Max. Betriebsdruck : 5 bar
Min. Betriebsdruck : 1 bar
Druckgleichheit empfehlenswert.
Ideale Wassertemperatur : 60°C
Max. Wassertemperatur : 70°C

Presión ideal de servicio : 3 bar
Presión máxima de servicio : 5 bar
Presión mínima de servicio : 1 bar
Se recomienda la igualdad de las presiones.
Temperatura ideal del agua : 60°C
Temperatura máxima del agua : 70°C



Achtung:
Vor Montage die Leitungen gründlich durchspülen!



Atención:
¡Enjuagar escrupulosamente las tuberías antes del montaje!

Weitere Informationen finden Sie in unseren detaillierten Verkaufsunterlagen.

Información más detallada en nuestra documentación de ventas.

Pressione di servizio ideale : 3 bar
Pressione di servizio mass. : 5 bar
Pressione di servizio min. : 1 bar
Si raccomanda pressioni uguali.
Temperatura acqua calda ideale : 60°C
Temperatura acqua calda mass. : 70°C

Ideal operating pressure : 3 bar / 45 PSI / 300 kPa
Max. operating pressure : 5 bar / 70 PSI / 500 kPa
Min. operating pressure : 1 bar / 14.5 PSI / 100 kPa
Equal pressures are recommended.
Ideal water temperature : 60°C (140°F)
Max. water temperature : 70°C (158°F)



Attenzione:
Risciacquare bene le tubazioni prima del montaggio!



Attention:
Flush pipes thoroughly before installation!

Ulteriori informazioni le troverete nelle nostre dettagliate documentazioni.

For further information refer to our detailed sales literature.

Pression de service idéale : 3 bar
Pression de service max. : 5 bar
Pression de service min. : 1 bar
Égalité de pression recommandée.
Température idéale de l'eau : 60°C
Température max. de l'eau : 70°C

Driftstryck : 3 bar / 300 kPa
Max. tryck : 5 bar / 500 kPa
Min. tryck : 1 bar / 100 kPa
Lika tryck på kall- och varmvatten rekommenderas.
Driftstemperatur : 60°C
Max temperatur : 70°C



Attention:
Rincer à fond la tuyauterie avant le montage!



O.B.S.
Spola rören ordentligt innan blandare installeras!

Pour informations supplémentaires voir nos documentations de vente détaillées.

För ytterligare information se produktblad.

KWC VG
KWC Deutschland GmbH
Junghansring 70
DE-72108 Rottenburg
+49 (0) 7457 948 56 0
+49 (0) 7457 948 56 30

Franke WS/KS
Franke S.p.A.
Via Pignolini 2
IT - 37019 Peschiera del Garda
+39 (045) 644 931 1

Franke WS/KS
Franke Consumer Products
Luxury Products Group
800 Aviation Parkway
 Smyrna, TN 37167 USA
+1 800-626-5771

Franke WS
Franke GmbH
Oberer Achdamm 52
AT-6971 Hard
+43 (0) 557 467 350
+43 (0) 557 462 411

Franke WS/KS
Franke L.L.C.
RAK Industrial Zone, P.O. Box 14511
AE-Ras Al Khaimah, UAE
+971 7 203 47 00
+971 7 203 47 60

Franke WS
Franke Water Systems
Ring-Oost 10
BE-9400 Ninove
+32 (0) 54 31 01 30
+32 (0) 54 31 01 35

Franke KS
Franke NV
Ring 10
BE-9400 Ninove
+32 (0) 54 31 01 11
+32 (0) 54 32 36 88

Franke KS
Franke GmbH
Mumpferfahrstrasse 70
DE-79713 Bad Säckingen
+49 (0) 7761 52 0
+49 (0) 7761 52 294

Franke KS
Franke France S.A.S.
Avenue Aristide Briand BP 13
FR-60230 Chambly
+331 30 28 94 00
+331 30 28 94 30

Franke KS
Franke UK Limited
West Park, MIOC, Styal Road
GB-Manchester M22 5WB
+44 161 436 62 80
+44 161 437 13 79

Franke KS
Franke Nederland B.V.
Lagedijk 13
NL-5705 Bx Helmond
+31 492 585 111
+31 492 585 200

Umgebungsbedingungen

In unmittelbarer Nähe von Armaturen und Anschlussschläuchen dürfen keine Reinigungsmittel und Chemikalien gelagert werden.

Austretende Dämpfe können die Armatur und die Anschlussschläuche beschädigen.

Conditions d'environnement

Aucun produit de nettoyage ni détergent chimique ne doit être stocké à proximité immédiate des robinetteries et des raccords flexibles.

Les vapeurs qui s'en échappent risqueraient d'endommager les robinetteries et les raccords flexibles.

Ambiente circostante

Non conservare detersivi o sostanze chimiche nelle immediate vicinanze della rubinetteria e dei tubi flessibili di collegamento.

L'esalazione di vapori potrebbe danneggiare la rubinetteria e i tubi flessibili.

Condiciones del entorno

Cerca de las griferías y conexiones de tubos flexibles no se deben almacenar productos químicos ni de limpieza.

Los eventuales vapores podrían dañar la grifería y las conexiones de tubos flexibles.

Environmental conditions

No cleaning agents or chemicals should be stored in the immediate vicinity of faucets and connection hoses.

Any vapour emitted may damage the faucet and connection hoses.

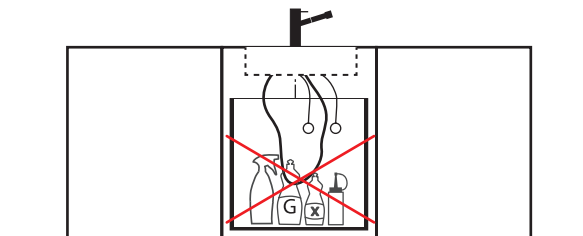
**Periodische Kontrolle**

Die Anschluss- und Brausenschläuche müssen aus Sicherheitsgründen periodisch auf folgende Punkte kontrolliert werden:

Dichtheit

Feuchte oder tropfende Schläuche müssen ersetzt werden.

Korrosionsschäden

Schläuche mit rostiger oder oxidiert Oberfläche müssen ersetzt werden.

Mechanische Beschädigung

Schläuche, welche eine mechanische Beschädigung aufweisen, müssen ersetzt werden.

Contrôle périodique

Pour des raisons de sécurité, les flexibles de douche et de raccordement doivent être contrôlés périodiquement pour vérifier les points suivants:

Etanchéité

Les flexibles humides ou qui gouttent doivent être remplacés.

Dommages dus à la corrosion

Les flexibles oxydés en surface doivent être remplacés.

Dommages mécaniques

Les flexibles qui présentent des dommages mécaniques doivent être remplacés.

Controlli periodici

Per ragioni di sicurezza, è necessario sottoporre a controlli periodici i tubi flessibili di collegamento e delle docce in merito ai seguenti aspetti.

Tenuta

I tubi umidi o non a tenuta devono essere sostituiti.

Danni da corrosione

I tubi che presentano una superficie arrugginita oppure ossidata devono essere sostituiti.

Danni meccanici

I tubi che presentano danni meccanici devono essere sostituiti.

Control periódico

Por razones de seguridad, las conexiones de tubos flexibles y los flexos de ducha se deben controlar periódicamente respecto a los siguientes puntos:

Estanqueidad

Se deben sustituir los tubos flexibles húmedos o que gotean.

Daños por corrosión

Se deben sustituir los tubos flexibles con óxido o herrumbre en la superficie.

Daños mecánicos

Se deben sustituir los tubos flexibles que presentan daños mecánicos.

Periodic checks

For safety reasons, the connection and shower hoses must be checked periodically for the following:

Watertightness

Damp or dripping hoses must be replaced.

Corrosion

Hoses with rusty or oxidized surfaces must be replaced.

Mechanical damage

Hoses that show signs of mechanical damage must be replaced.

Befestigung
Fixation
Fissaggio
Fijación
Connection

EU/AUS

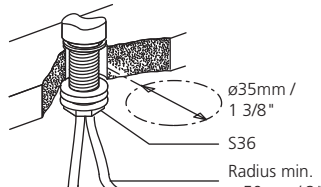
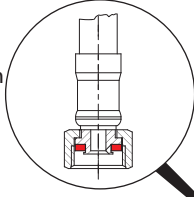

USA/CAN

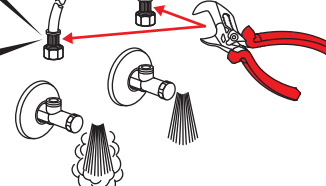
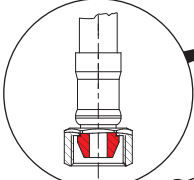

Beim Anschliessen zwingend gemäss Abbildung oberhalb der Mutter gehalten!

Pour le raccordement, il est impératif d'appliquer une force contraire au-dessus de l'écrou (voir illustration)!

Eseguire il collegamento sopra il dado secondo la figura.

Al conectar, sujetar por encima de la tuerca siguiendo exactamente el dibujo

Hold above the nut during installation as shown in the illustration.

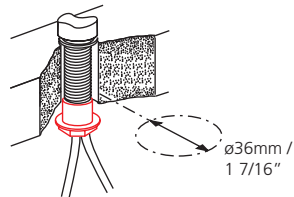
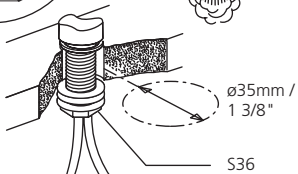

Z.503.315

Verlängerungsmutter L= 40mm
Ecrou allongé L= 40mm
Dado prolungato L= 40mm
Tuerca de prolongación L= 40mm
Extension nut L= 40mm / 1 1/2"

Inbetriebsetzung
Mise en service
Messa in funzione
Puesta en servicio
Initial operation

1

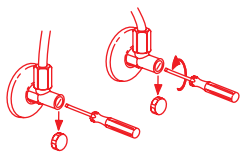

Kalt- und Warmwasser öffnen.

Ouvrir eau froide et chaude.

Aprire acqua fredda e calda.

Abrir la salida de agua fría y caliente.

Open cold and hot water.

2



3

|||||| D spülen
|||||| F rincer
|||||| I sciacquare
|||||| Sp enjuagar
|||||| E flush

4

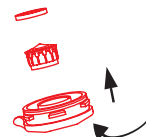

2



3

|||||| D spülen
|||||| F rincer
|||||| I sciacquare
|||||| Sp enjuagar
|||||| E flush

4



Höchsttemperaturbegrenzung
 Limitation de la température max.
 Limitazione della temperatura massima
 Limitación de la temperatura máxima
 Maximum temperature limitation

Temperurring
 Anneau de limitation
 Anello di limitazione
 Anillo de la temperatura
 Temperature ring

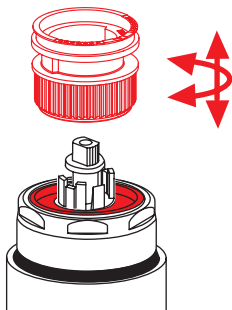

Max. Temperaturbereich :
 Plage de température max. :
 Campo di temperatura mass. :
 Gama de temperaturas máx. :
 Max. temperature range :

Begrenzter Temperaturbereich :
 Plage de température réduite :
 Campo di temperatura ridotto :
 Gama de temperaturas reducidas :
 Reduced temperature range :

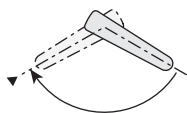
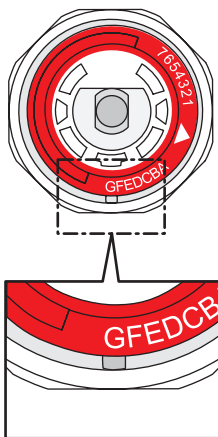
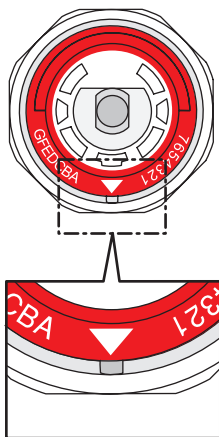

Pfeil auf Kerbe.
 Flèche sur encoche.
 Freccia su scanalatura.
 Flecha en la hendidura.
 Arrow on groove.

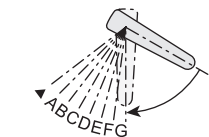

Position A - G
 Position A - G
 Position A - G
 Posición A - G
 Positions A - G

Mengenbegrenzung
 Limitation du débit
 Limitazione della portata
 Limitación del caudal
 Flow rate limitation

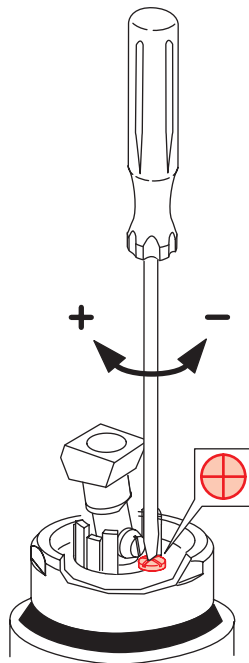

Montage des Schlauchstop's
 Montage du stop
 Montaggio del stop
 Montaje del stop
 Installation of limit stop

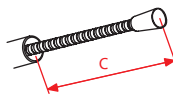

$c = 700 \text{ mm}, 27 \frac{9}{16}''$

$d = 500 \text{ mm}, 19 \frac{11}{16}''$

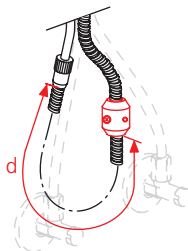

Ersatzteile
Pièces de rechange
Pezzi di ricambio
Repuestos
Spare parts

Es dürfen ausschliesslich **original Ersatzteile** verwendet werden!
Utiliser seulement des **pièces de rechange originaux!**
Usare soltanto i **pezzi di ricambio originali!**
¡Utilizar solamente los **Requetos originales!**
Only the **original Spare parts** may be used!

10.271.023.700

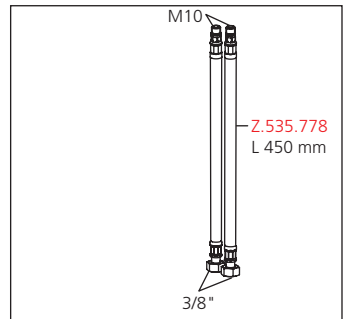
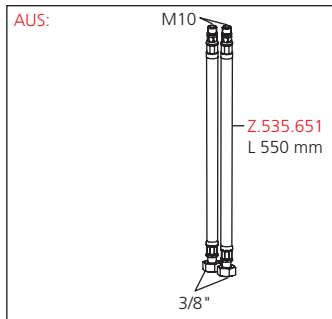
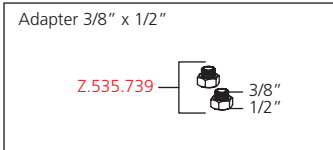
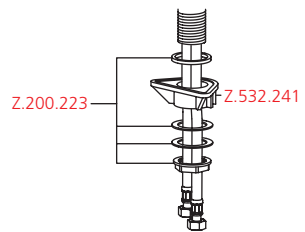
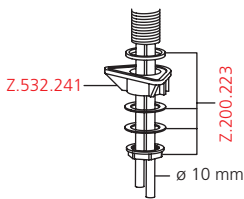
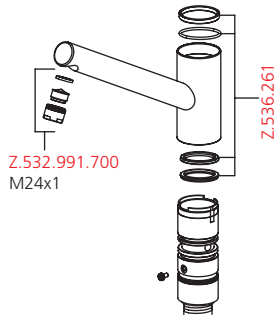
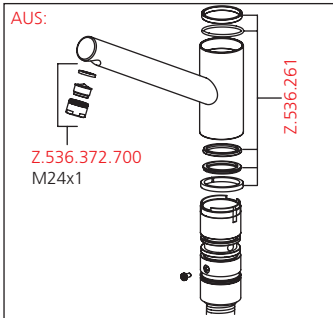
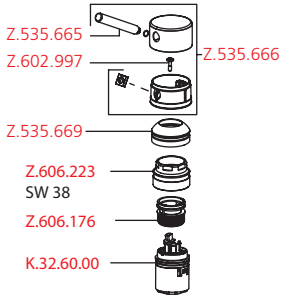

Ersatzteile

Es dürfen ausschliesslich **original Ersatzteile** verwendet werden!

Pièces de rechange

Utiliser seulement des **pièces de rechange originaux!**

Pezzi di ricambio

Usare soltanto i **pezzi di ricambio originali!**

Repuestos

¡Utilizar solamente los **Requestos originales!**

Spare parts

Only the **original Spare parts** may be used!

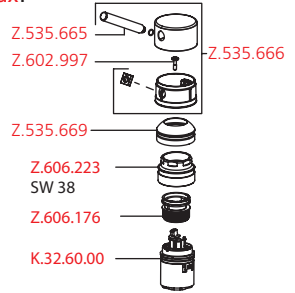

10.271.033.736

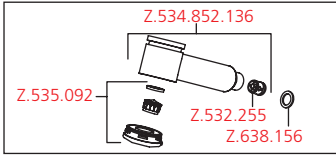

10.271.033.700

10.271.333.700

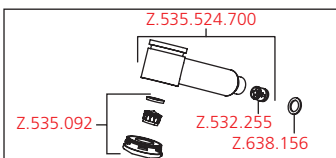

10.271.103.700

10.271.303.700

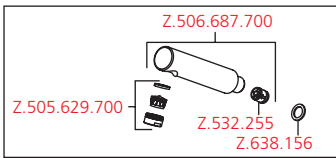

Adapter 3/8" x 1/2"

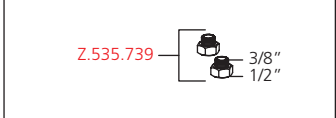

USA/CAN:

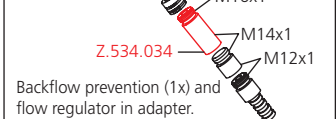

AUSTRALIA:

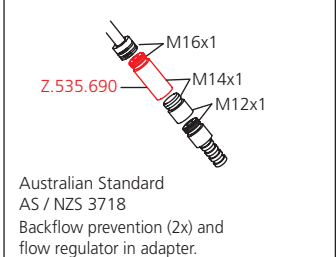

10.271.033.700

10.271.033.700

10.271.103.700

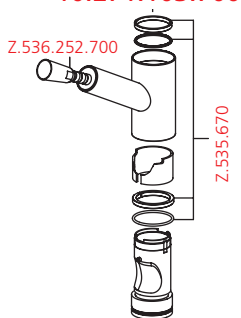

10.271.303.700

10.271.333.700 (USA only)

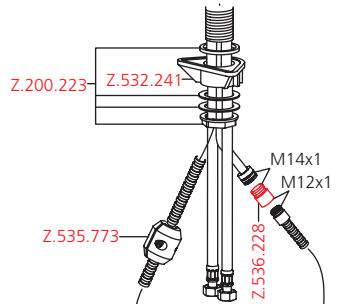
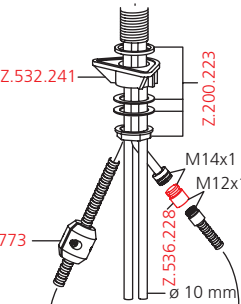
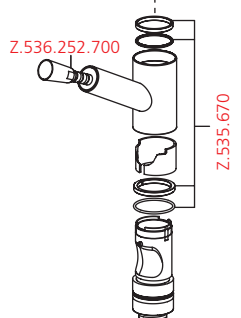

USA/CAN:

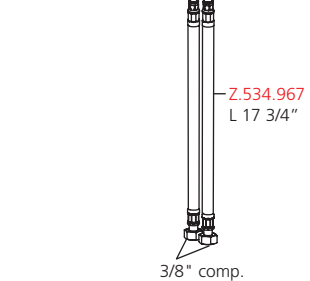

AUS:

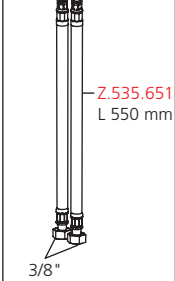

EU:

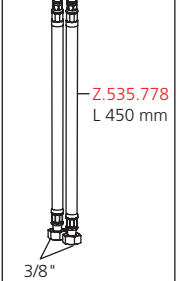

Pflegeanleitung für Armaturen und Zubehör
Instruction pour la maintenance des robinets et des accessoires
Istruzioni per la manutenzione di rubinetti e accessori
Instrucciones para el cuidado de griferías y accesorios
Maintenance / Cleaning instructions for faucets and accessories

Grundsätzliche Reinigungshinweise:

- Beim Reinigen muss die Oberfläche der Armatur kalt sein (Wärme beschleunigt die Zerstörung der Oberfläche)!
- Reinigungshinweise der Reinigungsmittelhersteller beachten!

Die Pflege:

- Armatur täglich mit weichem Lappen trocken reiben!
- Scheuernde Reinigungsmittel und Putzschwämme unbedingt vermeiden!

Die Reinigung:

- Schmutz- oder Kalkflecken auf der Armaturenoberfläche nur mit mildem Reinigungsmittel entfernen!
- Sofort nach dem Reinigen alle Reinigungsmittelrückstände mit kaltem Wasser wegspülen!
- Mit weichem Lappen trocken reiben.

Instructions principales pour le nettoyage:

- Durant le nettoyage, la surface du robinet doit être froide (la chaleur accélère l'usure de la surface)!
- Nous vous prions de faire attention aux indications mentionnées sur les nettoyages!
- Assurez vous que les produits ne contiennent pas d'acides ou des substances corrosives.

L'entretien:

- Le robinet doit être nettoyé chaque jour avec un chiffon mou.
- Evitez absolument l'usage des brillants pour métaux, éponges abrasives ou produits similaires!

Le nettoyage:

- Enlevez salissures et dépôts calcaires de la surface du robinet seulement avec des produits qui ne sont pas agressifs!
- Immédiatement après le nettoyage, rincer bien les résidus des détergents avec de l'eau froid!
- Sécher avec un chiffon mou.

Principali istruzioni per la pulizia:

- Durante la pulizia, la superficie del rubinetto deve essere fredda (il calore accelera il logorio della superficie)!
- Fare attenzione alle indicazioni riportate sui prodotti per la pulizia!
- Accertarsi che non contengano acidi o sostanze corrosive.

La manutenzione:

- Il rubinetto deve essere asciugato quotidianamente con un panno morbido.
- Evitare assolutamente paglietta, spugne abrasive o similari!

La pulizia:

- Togliere sporco e calcare dalla superficie del rubinetto solo con detersivi non aggressivi!
- Subito dopo la pulizia, sciacquare bene i residui di detersivo con acqua fredda!
- Asciugare con un panno morbido.

Avisos básicos de limpieza:

- Cuando se procede a limpiar la grifería, su superficie debe estar fría (el calor acelera la destrucción de la superficie)!
- Respetar los avisos de limpieza del fabricante del detergente!

Cuidado:

- Secar la grifería frotando diariamente con un paño blando!
- Evite, imprescindiblemente, detergentes y esponjas de limpieza raspantes!

Limpeza:

- Quitar las manchas de suciedad o cal en la superficie de la grifería sólo con un detergente poco agresivo!
- Inmediatamente después de la limpieza eliminar, enjuagando con agua fría, todos los residuos del detergente!
- Secar frotando con un paño blando.

General Cleaning Instructions:

- Faucet surface must be of room temperature before cleaning (elevated temperature increases damage of the surface).
- Cleaning instructions of the detergent manufacturer must be followed.

Maintenance:

- Rub the faucet daily dry with a soft cloth.
- Never use corrosive cleaners or cleaning pads.

Cleaning:

- Dirt or calcium deposits on the faucet surface must be removed with soft detergent or with soap water!
- Rinse well with water immediately after cleaning, until all detergent is removed from the surface.
- Dry with soft cloth.

Skötsel och underhåll:

- Blandaren skall vara rumstempererad innan rengöring (högre temperatur kan vara skadlig för ytbehandlingen).
- Instruktioner från rengöringsmedeltillverkaren skall följas.

Underhåll:

- Torka av blandaren dagligen med en mjuk trasa
- Använd aldrig kalklösande, sura- eller slipande skurmedel och svampar.

Rengöring:

- Smuts eller kalkavlagringar på blandarytan tas bort med mildt rengöringsmedel eller mild tvällösning.
- Eftersköljning med rent vatten tills allt rengöringsmedel är borta.
- Torka med mjuk trasa.



- D Schäden, die infolge unsachgemässer Behandlung, natürlicher Abnutzung oder zu grosser Inanspruchnahme entstanden sind, sind von unseren Garantieleistungen ausgeschlossen!
- F Ces dommages survenus en raison d'un traitement inadéquat, des signes d'usure traitement inadéquat, naturels ou du grand utilisation, sont exclus de notre garantie.
- I Danni ai rubinetti, conseguenti da un trattamento non appropriato, sono esclusi dalla nostra garanzia!
- Sp Daños, debidos a un tratamiento inadecuado, son excluidos de la nuestra garantía.
- E Damages on the faucet resulting from incorrect handling are excluded from the manufacturers warranty!
- S För att Garantien skall gälla skall blandaren vara monterad och använd på ett korrekt sätt.

Technische Änderungen vorbehalten
 Salvo cambiamenti tecnici
 Sous réserve de modifications techniques
 Derechos reservados para efectuar modificaciones técnicas
 Subject to technical alteration
 Med förbehåll för tekniska ändringar