



KWC

KWC GASTRO E

Always a
class ahead

Always a class ahead

KWC GASTRO E – the premium stainless-steel solution for the catering industry.

True professional kitchens dazzle with fittings from the KWC GASTRO E line made of pure V4A stainless steel. This means a longer service life thanks to the acid and chloride resistance, higher hygiene standards, greater safety and sustainability – also thanks to the extremely robust material.

The KWC GASTRO E line range is extensive. The variants can be combined and expanded with extension elements for any application. Another highlight is the robust dish spray with swivelling faceplate for maximum ease of use.





KWC GASTRO E

Premium in every detail



Innovative operation

The faceplate can be angled by 45° with a simple flick of the wrist. Maximum convenience in the professional kitchen and a genuine innovation from the KWC brand.

Rewarding care

The dish spray can be shut off for cleaning. It features delayed closing for pressure shock damping, and a valve maintenance unit. This ensures that the tap can be reliably maintained, which in turn helps increase its service life.



Unbeatable advantages

Cleaning is easy and hygiene is excellent because stainless steel does not provide a breeding ground for bacteria. Stainless steel is durable, robust, leaches out virtually no heavy metals and can be fully recycled – ex works sustainability included.

Individual optimisation

Two different base lengths allow the tap height to be adjusted. The flexible connection hoses simplify and speed up installation. The 360° swivel range rounds off the ease of use perfectly.

A durable solution

The soft packing between the spout and the body is made of hemp. When in use, humidity expands the plant fibre, and only then is the nut tightened. For a perfect seal, simply retighten the nut slightly.

A practical detail

A simple solution called Drip-Stop. The optional accessory reliably prevents water from dripping. Particularly useful if the tap is positioned close to the hob.

KWC GASTRO E

Premium quality from Unterkulm

True top performance

The KWC high-performance cartridge impresses with an exceptionally high flow rate – premium in everyday life, quality for decades, made by KWC.



Easy cleaning

The dish spray can be dismantled to clean or replace the valve and spray individually.



Dual-jet all-rounder

The water-saving dish spray offers two jet types. The conical cleaning jet is ideal for gentle washing, the high-performance jet for heavy soiling. The faceplate is adjustable, which makes work easier and protects the spray hose.

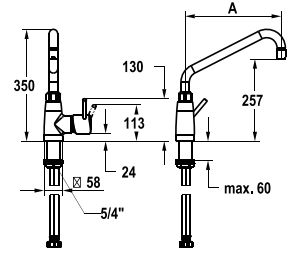
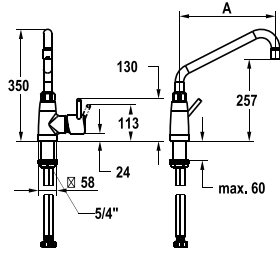

SAP Nr. **Artikel Nr.**

stainless steel, A 300, flexible connection hoses
125565 24.561.044.700FL

GASTRO E Lever mixer - Commercial kitchen

- Lever mixer
- Swivel spout 360°
 - with adjustable gland
 - Jet regulator
- OptimalSpace - ample space for washing or working
- KWC Cartridge XL 46 - High capacity
 - with ceramic discs
 - flow rate and temperature continuously variable
 - temperature limitation
- Flexible connection hoses 1/2" with transition to 3/4"
- Fastening by means of threaded sleeve 1 1/4"
- Mounting hole size ø42 mm
- To be ordered separately:
 - Socket 100 mm Z.539.000.700 or 300 mm Z.539.001.700

Flow rate 32.4 l/min (3 bar)
 Acoustic group II



SAP Nr. **Artikel Nr.**

stainless steel, A 450, flexible connection hoses
125566 24.561.046.700FL

GASTRO E Lever mixer - Commercial kitchen

- Lever mixer
- Swivel spout 360°
 - with adjustable gland
 - Jet regulator
- OptimalSpace - ample space for washing or working
- KWC Cartridge XL 46 - High capacity
 - with ceramic discs
 - flow rate and temperature continuously variable
 - temperature limitation
- Flexible connection hoses 1/2" with transition to 3/4"
- Fastening by means of threaded sleeve 1 1/4"
- Mounting hole size ø42 mm
- To be ordered separately:
 - Socket 100 mm Z.539.000.700 or 300 mm Z.539.001.700

Flow rate 32.4 l/min (3 bar)
 Acoustic group II

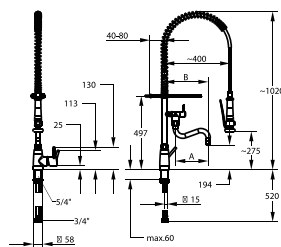

SAP Nr.

Artikel Nr.

stainless steel, A 200, B 270, flexible connection hoses
125567 24.561.144.700FL

GASTRO E Lever mixer - Commercial kitchen

- Lever mixer
- stainless steel suspension spring
- TouchProtect - anti-scald protection thanks to the "double skin" principle
- Inherently safe against backflow and cross flow
- Swivel spout
 - with adjustable gland
 - Jet regulator
- Pre-rinse spray
 - with integrated delayed closing device to minimize water hammer
 - with valve maintenance unit for cleaning
 - SprayClean - easy to clean and actively prevents limescale buildup
 - SprayLock - lockable jet spray
 - PowerClean - needle spray mode
- OptimalSpace - ample space for washing or working
- KWC Cartridge XL 46 - High capacity
 - with ceramic discs
 - flow rate and temperature continuously variable
 - temperature limitation
- Flexible connection hoses ½" with transition to ¾"
- Fastening by means of threaded sleeve 1 ¼"
- Mounting hole size ø42 mm

Flow rate 27 l/min (3 bar)

Spray: Flow rate 15 l/min (3 bar)

Acoustic group II

Spray: Acoustic group I

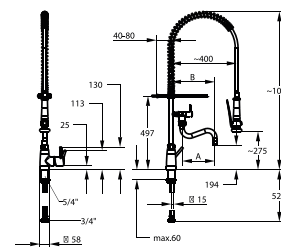

SAP Nr.

Artikel Nr.

stainless steel, A 300, B 370, flexible connection hoses
125568 24.561.146.700FL

GASTRO E Lever mixer - Commercial kitchen

- Lever mixer
- Stainless steel suspension spring
- TouchProtect - anti-scald protection thanks to the "double skin" principle
- Inherently safe against backflow and cross flow
- Swivel spout
 - with adjustable gland
 - Jet regulator
- Pre-rinse spray
 - with integrated delayed closing device to minimize water hammer
 - with valve maintenance unit for cleaning
 - SprayClean - easy to clean and actively prevents limescale buildup
 - SprayLock - lockable jet spray
 - PowerClean - needle spray mode
- OptimalSpace - ample space for washing or working
- KWC Cartridge XL 46 - High capacity
 - with ceramic discs
 - flow rate and temperature continuously variable
 - temperature limitation
- Flexible connection hoses ½" with transition to ¾"
- Fastening by means of threaded sleeve 1 ¼"
- Mounting hole size ø42 mm

Flow rate 27 l/min (3 bar)

Spray: Flow rate 15 l/min (3 bar)

Acoustic group II

Spray: Acoustic group I

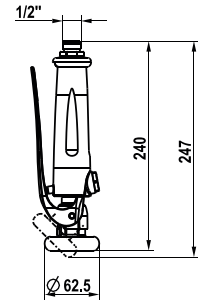
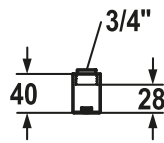
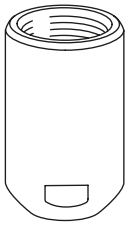

SAP Nr.	Artikel Nr.
G 3/4" 360006994	Z.530.928.700

GASTRO Drip-Stop

- Drip-Stop
- Prevents residual spout flow
- Suitable for:
 - KWC GASTRO E

SAP Nr.	Artikel Nr.
graphite gray, G 1/2" 539030	Z.539.030.145

GASTRO Pre-rinse spray

- Pre-rinse spray
 - with integrated delayed closing device to minimize water hammer with valve maintenance unit for cleaning and swivelling sieve jet
- Connecting thread 1/2"

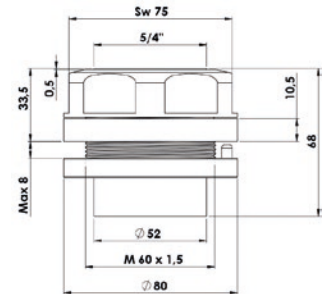
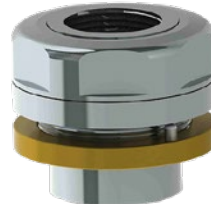
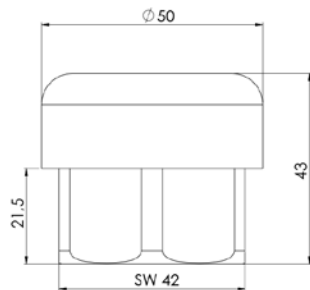

SAP Nr.	Artikel Nr.
chromeline 300061	300061

Outlet swivel limiter M 38 x 15

- Suitable for:
 - KWC GASTRO
 - 2-handle and lever mixer
 - one hole / 2-hole + wall mixer 3/4"
 - limitation individually adjustable

SAP Nr.	Artikel Nr.
chromeline, G 1 1/4" 300019	300019

Preassembled socket 5/4 zu KWC

- Mounting hole size $\varnothing 60.5$ mm
- Suitable for:
 - KWC GASTRO
 - 2-handle and lever mixer
 - One hole mixer

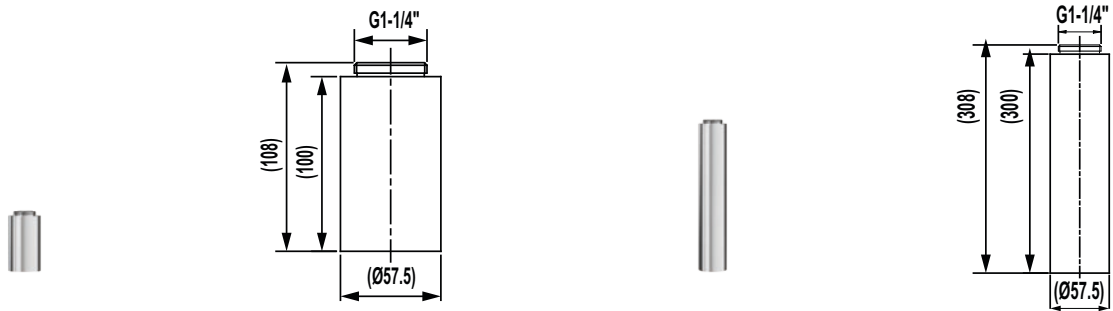

SAP Nr.	Artikel Nr.
stainless steel 539000	Z.539.000.700

GASTRO E Socket 100 mm

- Socket 100 mm
- Suitable for:
 - KWC GASTRO E

SAP Nr.	Artikel Nr.
stainless steel 539001	Z.539.001.700

GASTRO E Socket 300 mm

- Socket 300 mm
- Suitable for:
 - KWC GASTRO E



The ultimate
choice